

19 August 2013

Agreement

Concerning the Adoption of Uniform Technical Prescriptions for Wheeled Vehicles, Equipment and Parts which can be Fitted and/or be Used on Wheeled Vehicles and the Conditions for Reciprocal Recognition of Approvals Granted on the Basis of these Prescriptions*

(Revision 2, including the amendments which entered into force on 16 October 1995)

Addendum 45: Regulation No. 46

Revision 5

Incorporating all valid text up to:

Supplement 1 to the 03 series of amendments - Date of entry into force: 18 November 2012

04 series of amendments - Date of entry into force: 15 July 2013

Uniform provisions concerning the approval of devices for indirect vision and of motor vehicles with regard to the installation of these devices



UNITED NATIONS

* Former title of the Agreement: Agreement Concerning the Adoption of Uniform Conditions of Approval and Reciprocal Recognition of Approval for Motor Vehicle Equipment and Parts, done at Geneva on 20 March 1958.

Regulation No. 46

Uniform provisions concerning the approval of devices for indirect vision and of motor vehicles with regard to the installation of these devices

Contents

	Page
1. Scope	5
I. Devices for indirect vision	
2. Definitions	5
3. Application for approval	8
4. Markings	8
5. Approval	8
6. Requirements	9
7. Modification of the type of device for indirect vision and extension of approval.....	19
8. Conformity of production	20
9. Penalties for non-conformity of production	20
10. Production definitively discontinued	20
11. Names and addresses of Technical Services responsible for conducting approval tests, and of Type Approval Authorities.....	20
II. Installation of devices for indirect vision	
12. Definitions	21
13. Application for approval	22
14. Approval	22
15. Requirements	22
16. Modifications of the vehicle type and extension of approval	39
17. Conformity of production	40
18. Penalties for non-conformity of production	40
19. Production definitively discontinued	40
20. Names and addresses of Technical Services responsible for conducting approval tests, and of Type Approval Authorities	40
21. Transitional provisions	40

Annexes

1	Information document for type approval of a device for indirect vision	43
2	Information document for type approval of vehicle with respect to the installation of devices for indirect vision	44
3	Communication concerning the approval or refusal or extension or withdrawal of approval or production definitively discontinued of a type of device for indirect vision, pursuant to Regulation No. 46	46
4	Communication concerning the approval or refusal or extension or withdrawal of approval or production definitively discontinued of a type of vehicle with regard to the mounting of devices for indirect vision, pursuant to Regulation No. 46	48
	Appendix	49
5	Arrangement of approval mark for a device for indirect vision	50
6	Test method for determining reflectivity	51
7	Procedure for determining the radius of curvature "r" of the reflecting surface of a mirror	57
8	Procedure for determining the "H" point and the actual torso angle for seating positions in motor vehicles	59
	Appendix 1 - Description of the three-dimensional "H" point machine (3-D H machine).....	59
	Appendix 2 - Three-dimensional reference system	59
	Appendix 3 - Reference data concerning seating positions	59
9	(Reserved)	60
10	Calculation of the detection distance	61
11	Determination of the displayed object size	64

1. Scope

This Regulation applies:

- (a) To compulsory and optional devices for indirect vision, set out in the table under paragraph 15.2.1.1.1. of this Regulation for vehicles of category M and N¹ and to compulsory and optional devices for indirect vision mentioned in paragraphs 15.2.1.1.3. and 15.2.1.1.4. of this Regulation for vehicles of category L¹ with bodywork at least partly enclosing the driver;
- (b) To the installation of devices for indirect visions on vehicles of categories M and N and on vehicles of category L¹ with bodywork at least partly enclosing the driver.

I. Devices for indirect vision

2. Definitions

For the purposes of this Regulation:

- 2.1. "*Devices for indirect vision*" means devices to observe the traffic area adjacent to the vehicle which cannot be observed by direct vision. These can be conventional mirrors, camera-monitors or other devices able to present information about the indirect field of vision to the driver.
 - 2.1.1. "*Mirror*" means any device, excluding devices such as periscopes, intended to give a clear view to the rear, side or front of the vehicle within the fields of vision defined in paragraph 15.2.4. of this Regulation.
 - 2.1.1.1. "*Interior mirror*" means a device as defined in paragraph 2.1. above, which can be fitted in the passenger compartment of a vehicle.
 - 2.1.1.2. "*Exterior mirror*" means a device as defined in paragraph 2.1. above, which can be mounted on the external surface of a vehicle.
 - 2.1.1.3. "*Surveillance mirror*" means a mirror other than the ones defined in paragraph 2.1.1. above which can be fitted to the inside or outside of the vehicle in order to provide fields of vision other than those specified in paragraph 15.2.4. of this Regulation.
 - 2.1.1.4. "*Vision support system*" means a system to enable the driver to detect and/or see objects in the area adjacent to the vehicle.
 - 2.1.1.5. "*r*" means the average of the radii of curvature measured over the reflecting surface, in accordance with the method described in Annex 7.
 - 2.1.1.6. "*The principal radii of curvature at one point on the reflecting surface (r_i)*" means the values obtained with the apparatus defined in Annex 7, measured on the arc of the reflecting surface passing through the centre of this surface

¹ As defined in the Consolidated Resolution on the Construction of Vehicles (R.E.3.), document ECE/TRANS/WP.29/78/Rev.2, para. 2. - www.unece.org/trans/main/wp29/wp29wgs/wp29gen/wp29resolutions.html

parallel to the segment b, as defined in paragraph 6.1.2.1.2.1. of this Regulation and on the arc perpendicular to this segment.

- 2.1.1.7. "*The radius of curvature at one point on the reflecting surface (r_p)*" means the arithmetical average of the principal radii of curvature r_i and r_i' i.e.:

$$r_p = \frac{r_i + r_i'}{2}$$

- 2.1.1.8. "*Spherical surface*" means a surface, which has a constant and equal radius in all directions

- 2.1.1.9. "*Aspherical surface*" means a surface, which has only in one plane a constant radius.

- 2.1.1.10. "*Aspherical mirror*" means a mirror composed of a spherical and an aspherical part, in which the transition of the reflecting surface from the spherical to the aspherical part has to be marked. The curvature of the main axis of the mirror is defined in the x/y coordinate system defined by the radius of the spherical primary calotte with:

$$y = R - \sqrt{(R^2 - x^2)} + k(x - a)^3$$

R: nominal radius in the spherical part

k: constant for the change of curvature

a: constant for the spherical size of the spherical primary calotte

- 2.1.1.11. "*Centre of the reflecting surface*" means the centre of the visible area of the reflecting surface.

- 2.1.1.12. "*The radius of curvature of the constituent parts of the mirror*" means the radius "c" of the arc of the circle which most closely approximates to the curved form of the part in question.

- 2.1.1.13. "*Class of mirror*" means all devices having one or more common characteristics or functions. They are classified as follows:

- (a) Class I: "Interior rear-view mirror", giving the field of vision defined in paragraph 15.2.4.1. of this Regulation;
- (b) Classes II and III: "Main exterior rear-view mirror", giving the fields of vision defined in paragraphs 15.2.4.2. and 15.2.4.3. of this Regulation;
- (c) Class IV: "Wide-angle exterior mirror", giving the field of vision defined in paragraph 15.2.4.4. of this Regulation;
- (d) Class V: "Close-proximity exterior mirror", giving the field of vision defined in paragraph 15.2.4.5. of this Regulation;
- (e) Class VI: "Front mirror", giving the field of vision defined in paragraph 15.2.4.6. of this Regulation;
- (f) Class VII: Mirrors intended for L category vehicles with bodywork, giving the field of vision defined in paragraph 15.2.4.7. of this Regulation.

- 2.1.2. "Camera-monitor device for indirect vision" means a device as defined in paragraph 2.1., where the field of vision is obtained by means of a camera-monitor combination as defined in paragraphs 2.1.2.1. and 2.1.2.2. below.
- 2.1.2.1. "Camera" means a device that renders an image of the outside world and then converts this image into a signal (e.g. video signal).
- 2.1.2.2. "Monitor" means a device that converts a signal into images that are rendered into the visual spectrum.
- 2.1.2.3. "Detection" means the ability to distinguish an object from its background/surroundings at certain distance.
- 2.1.2.4. "Luminance contrast" means the brightness ratio between an object and its immediate background/surrounding that allows the object to be distinguished from its background/surroundings.
- 2.1.2.5. "Resolution" means the smallest detail that can be discerned with a perceptual system, i.e. perceived as separate from the larger whole. The resolution of the human eye is indicated as "visual acuity".
- 2.1.2.6. "Critical object" means a cylindrical object with a height of 0.50 m and a diameter of 0.30 m.
- 2.1.2.7. "Critical perception" means the level of perception that can just be obtained under critical conditions via the viewing system used. This corresponds to the situation in which the representative scale of the critical object is multiple times larger than the smallest detail that can be perceived via the viewing system.
- 2.1.2.8. "Field of vision" means the section of the tri-dimensional space which is monitored with the help of a device for indirect vision. Unless otherwise stated, this is based on the view on ground level offered by a device and/or devices other than mirrors. This may be limited by the relevant detection distance corresponding to the critical object.
- 2.1.2.9. "Detection distance" means the distance measured from the centre of the lens of the camera to the point at which a critical object can just be perceived (as defined by the critical perception).
- 2.1.2.10. (Reserved)
- 2.1.2.11. (Reserved)
- 2.1.2.12. "Visual spectrum" means light with a wavelength within the range of the perceptual limits of the human eyes: 380-780 nm.
- 2.1.2.13. "Surveillance camera-monitor-recording device" means a camera and either a monitor or recording equipment other than the camera-monitor device defined in paragraph 2.1.2. above which can be fitted to the inside or outside of the vehicle in order to provide fields of vision other than those specified in paragraph 15.2.4. of this Regulation or to provide a security system within or around the vehicle.
- 2.1.2.14. "Smear" is a vertical bright bar displayed on the monitor while sun light or light from other bright light sources is directly hitting into the lens of the camera. Smear is an optical artefact.
- 2.1.3. "Other devices for indirect vision" means devices as defined in paragraph 2.1. above, where the field of vision is not obtained by means of a mirror or a camera-monitor type device for indirect vision.

- 2.1.4. "Type of device for indirect vision" means devices that do not differ on the following essential characteristics:
- (a) Design of the device inclusive, if pertinent, the attachment to the bodywork;
 - (b) In case of mirrors the class, the shape, the dimensions and radius of curvature of the mirror's reflecting surface;
 - (c) In case of camera-monitor devices the detection distance and the range of vision.

3. Application for approval

- 3.1. The application for approval of a type of device for indirect vision shall be submitted by the holder of the trade name or mark or by his duly accredited representative.
- 3.2. A model of information document is shown in Annex 1.
- 3.3. For each type of device for indirect vision the application shall be accompanied by:
- 3.3.1. In case of mirrors, four samples: three for use in the tests and one to be retained by the laboratory for any further examination that might subsequently prove necessary. Additional specimens may be called for at the request of the laboratory;
 - 3.3.2. In case of other devices for indirect vision: one sample of all the parts.

4. Markings

- 4.1. The samples of devices for indirect vision submitted for approval shall bear the trade name or mark of the manufacturer; this marking shall be clearly legible and be indelible.
- 4.2. Every device shall possess a space large enough to accommodate the approval mark, which shall be legible when the device has been mounted on the vehicle; this space shall be shown on the drawings referred to in Annex 1.

5. Approval

- 5.1. If the samples submitted for approval meet the requirements of paragraph 6. of this Regulation, approval of the pertinent type of device for indirect vision shall be granted.
- 5.2. An approval number shall be assigned to each type approved. Its first two digits (at present 04) shall indicate the series of amendments incorporating the most recent major technical amendments made to the Regulation at the time of issue of the approval. The same Contracting Party shall not assign the same number to another type of device for indirect vision.
- 5.3. Notice of approval or of refusal or of extension or withdrawal of approval or of production definitively discontinued of a type of device for indirect vision pursuant to this Regulation shall be communicated to the Parties to the

Agreement which apply this Regulation by means of a form conforming to the model in Annex 3 to this Regulation.

- 5.4. There shall be affixed, conspicuously and in the space referred to in paragraph 4.2. above, to every device for indirect vision conforming to a type approved under this Regulation, in addition to the mark prescribed in paragraph 4.1. above, an international approval mark consisting of:
 - 5.4.1. A circle surrounding the letter "E" followed by the distinguishing number of the country which has granted approval²;
 - 5.4.2. An approval number;
 - 5.4.3. An additional symbol I or II or III or IV or V or VI or VII, specifying the class to which the type of mirror belongs or the symbol S in case of any device for indirect vision other than a mirror. The additional symbol shall be placed in any convenient position in the vicinity of the circle containing the letter "E".
- 5.5. The approval mark and the additional symbol shall be clearly legible and be indelible.
- 5.6. Annex 5 to this Regulation gives an example of the arrangement of the aforesaid approval mark and additional symbol.

6. Requirements

- 6.1. Mirrors
 - 6.1.1. General specifications
 - 6.1.1.1. All mirrors shall be adjustable.
 - 6.1.1.2. The edge of the reflecting surface shall be enclosed in a protective housing (holder, etc.) which, on its perimeter, shall have a value "c" greater than or equal to 2.5 mm at all points and in all directions. If the reflecting surface projects beyond the protective housing, the radius of curvature "c" on the edge of the projecting part shall be not less than 2.5 mm and the reflecting surface shall return into the protective housing under a force of 50 N applied to the point of greatest projection, relative to the protective housing, in a horizontal direction, approximately parallel to the longitudinal median plane of the vehicle.
 - 6.1.1.3. When the mirror is mounted on a plane surface, all parts, irrespective of the adjustment position of the device, including those parts remaining attached to the support after the test provided for in paragraph 6.1.3.2. below, which are in potential, static contact with a sphere either 165 mm in diameter in the case of an interior mirror or 100 mm in diameter in the case of an exterior mirror, shall have a radius of curvature 'c' of not less than 2.5 mm.

² The distinguishing numbers of the Contracting Parties to the 1958 Agreement are reproduced in Annex 3 to the Consolidated Resolution on the Construction of Vehicles (R.E.3), document ECE/TRANS/WP.29/78/Rev.2/Amend.3 - www.unece.org/trans/main/wp29/wp29wgs/wp29gen/wp29resolutions.html

- 6.1.1.4. The requirements in paragraphs 6.1.1.2. and 6.1.1.3. above shall not apply to parts of the external surface which protrude less than 5 mm, but the outward facing angles of such parts shall be blunted, save where such parts protrude less than 1.5 mm. For determining the dimension of the projection, the following method shall apply:
- 6.1.1.4.1. The dimension of the projection of a component which is mounted on a convex surface may be determined either directly or by reference to a drawing of an appropriate section of this component in its installed condition.
- 6.1.1.4.2. If the dimension of the projection of a component which is mounted on a surface other than convex cannot be determined by simple measurement, it shall be determined by the maximum variation of the distance of the centre of a 100 mm diameter sphere from the nominal line of the panel when the sphere is moved over and is in constant contact with that component. Figure 1 shows an example of the use of this procedure.

Figure 1

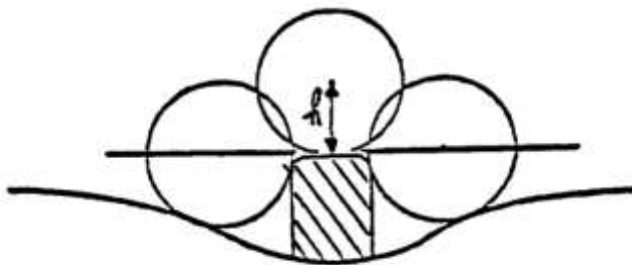

- 6.1.1.5. Edges of fixing holes or recesses of which the diameter or longest diagonal is less than 12 mm are exempt from the radius requirements of paragraph 6.1.1.3. above provided that they are blunted.
- 6.1.1.6. The device for the attachment of mirrors to the vehicle shall be so designed that a cylinder with a 70 mm radius (50 mm in the case of an L-category vehicle), having as its axis the axis, or one of the axes, of pivot or rotation which ensures deflection of the mirror in the direction of impact concerned, passes through at least part of the surface to which the device is attached.
- 6.1.1.7. The parts of exterior mirrors referred to in paragraphs 6.1.1.2. and 6.1.1.3. above which are made of a material with a Shore A hardness not exceeding 60 are exempt from the relevant provisions.
- 6.1.1.8. In the case of those parts of interior mirrors which are made of a material with a Shore A hardness of less than 50 and which are mounted on a rigid support, the requirements of paragraphs 6.1.1.2. and 6.1.1.3. above shall only apply to the support.

6.1.2. Special specifications

6.1.2.1. Dimensions

6.1.2.1.1. Interior rear-view mirrors (Class I)

The dimensions of the reflecting surface shall be such that it is possible to inscribe thereon a rectangle one side of which is 40 mm and the other 'a' mm in length, where

$$a = 150 \times \frac{1}{1 + \frac{1000}{r}} \text{ mm}$$

and "r" is the radius of curvature.

6.1.2.1.2. Main exterior rear-view mirrors (Classes II and III)

6.1.2.1.2.1. The dimensions of the reflecting surface shall be such that it is possible to inscribe therein:

- (a) A rectangle 40 mm high the base length of which, measured in millimetres, has the value "a";
- (b) A segment which is parallel to the height of the rectangle and the length of which, expressed in millimetres, has the value "b".

6.1.2.1.2.2. The minimum values of "a" and "b" are given in the table below:

<i>Class of rear-view mirror</i>	<i>a (mm)</i>	<i>b (mm)</i>
II	$\frac{170}{1 + \frac{1000}{r}}$	200
III	$\frac{130}{1 + \frac{1000}{r}}$	70

6.1.2.1.3. "Wide-angle" exterior mirrors (Class IV)

The contours of the reflecting surface shall be of simple geometric form and its dimensions such that it provides, if necessary in conjunction with a Class II exterior mirror, the field of vision specified in paragraph 15.2.4.4. of this Regulation.

6.1.2.1.4. "Close-proximity" exterior mirrors (Class V)

The contours of the reflecting surface shall be of simple geometric form and its dimensions such that the mirror provides the field of vision specified in paragraph 15.2.4.5. of this Regulation.

6.1.2.1.5. Front mirrors (Class VI)

The contours of the reflecting surface shall be of simple geometric form and its dimensions such that the mirror provides the field of vision specified in paragraph 15.2.4.6. of this Regulation.

- 6.1.2.1.6. Mirrors for category L vehicles with bodywork (Class VII)
- 6.1.2.1.6.1. "Main" exterior mirrors (Class VII)
- The minimum dimensions of the reflecting surface shall be such that:
- (a) Its area shall not be less than 6,900 mm²;
 - (b) The diameter of circular mirrors shall not be less than 94 mm;
 - (c) Where rear view mirrors are not circular, their dimensions shall enable a 78 mm-diameter circle to be prescribed on their reflecting surface.
- The maximum dimensions of the reflecting surface shall be such that:
- (a) The diameter of any circular rear view mirror shall not be greater than 150 mm;
 - (b) The reflecting surface of any non-circular rear view mirror shall lie within a rectangle measuring 120 mm x 200 mm.
- 6.1.2.2. Reflecting surface and coefficients of reflection
- 6.1.2.2.1. The reflecting surface of a mirror shall be either flat or spherically convex. Exterior mirrors may be equipped with an additional aspherical part provided that the main mirror fulfils the requirements of the indirect field of vision.
- 6.1.2.2.2. Differences between the radii of curvature of mirrors
- 6.1.2.2.2.1. The difference between r_i or r'_i , and r_p at each reference point shall not exceed 0.15 r.
- 6.1.2.2.2.2. The difference between any of the radii of curvature (r_{p1} , r_{p2} , and r_{p3}) and r shall not exceed 0.15 r.
- 6.1.2.2.2.3. When r is not less than 3,000 mm, the value of 0.15 r quoted in paragraphs 6.1.2.2.2.1. and 6.1.2.2.2.2. above is replaced by 0.25 r.
- 6.1.2.2.3. Requirements for aspherical parts of mirrors
- 6.1.2.2.3.1. Aspherical mirrors shall be of sufficient size and shape to provide useful information to the driver. This normally means a minimum width of 30 mm at some point.
- 6.1.2.2.3.2. The radius of curvature r_i of the aspherical part shall not be less than 150 mm.
- 6.1.2.2.4. Value of "r" for spherical mirrors shall not be less than:
- 6.1.2.2.4.1. 1,200 mm for interior rear-view mirrors (Class I);
 - 6.1.2.2.4.2. 1,200 mm for Class II and III main exterior rear-view mirrors;
 - 6.1.2.2.4.3. 300 mm for "wide-angle" exterior mirrors (Class IV) and "close-proximity" exterior mirrors (Class V);
 - 6.1.2.2.4.4. 200 mm for front mirrors (Class VI).
 - 6.1.2.2.4.5. 1,000 mm or more than 1,500 mm in the case of Class VII mirrors
- 6.1.2.2.5. The value of the normal coefficient of reflection, as determined according to the method described in Annex 6, shall be not less than 40 per cent.
- In the case of reflecting surfaces with a changeable degree of reflection, the "day" position shall allow the colours of the signals used for road traffic to be recognized. The value of the normal coefficient of reflection in the "night" position shall be not less than 4 per cent.

6.1.2.2.6. The reflecting surface shall retain the characteristics laid down in paragraph 6.1.2.2.5. above in spite of prolonged exposure to adverse weather conditions in normal use.

6.1.3. Test

6.1.3.1. Mirrors in Classes I to VI and Class VII (having fitments identical to Class III) shall be subjected to the tests described in paragraphs 6.1.3.2.1. and 6.1.3.2.2. below. Class VII mirrors with a stem, shall be subjected to the tests described in paragraph 6.1.3.2.3. below.

6.1.3.1.1. The test provided for in paragraph 6.1.3.2. below shall not be required in the case of any exterior mirror of which no part is less than 2 m from the ground, regardless of the adjustment position, when the vehicle is under a load corresponding to its maximum technically permissible mass.

This derogation also applies to the attachments of mirrors (attachment plates, arms, swivel joints, etc.) which are situated less than 2 m from the ground and which do not project beyond the overall width of the vehicle, measured in the transverse plane passing through the lowest mirror attachments or any other point forward of this plane if this configuration produces a greater overall width.

In such cases, a description specifying that the mirror shall be mounted so as to conform to the above-mentioned conditions for the positioning of its attachments on the vehicle shall be provided.

Where advantage is taken of this derogation, the arm shall be indelibly marked with the symbol

Δ
2m

and the type approval certificate shall be endorsed to this effect.

6.1.3.2. Impact test

The test according to this paragraph is not to be carried out for devices integrated in the bodywork of the vehicle and providing a frontal deflecting area of an angle not more than 45° measured in relation to the longitudinal median plane of the vehicle, or devices not protruding more than 100 mm measured beyond the circumscribing bodywork of the vehicle according to Regulation No. 26.

6.1.3.2.1. Description of the test rig

6.1.3.2.1.1. The test rig consists of a pendulum capable of swinging about two horizontal axes at right angles to each other, one of which is perpendicular to the plane containing the "release" trajectory of the pendulum.

The end of the pendulum comprises a hammer formed by a rigid sphere with a diameter of 165 ± 1 mm having a 5 mm thick rubber covering of Shore A hardness 50.

A device is provided which permits determination of the maximum angle assumed by the arm in the plane of release.

A support firmly fixed to the structure of the pendulum serves to hold the specimens in compliance with the impact requirements specified in paragraph 6.1.3.2.2.6. below.

Figure 1 below gives the dimensions (in mm) of the test rig and the special design specifications:

Figure 1

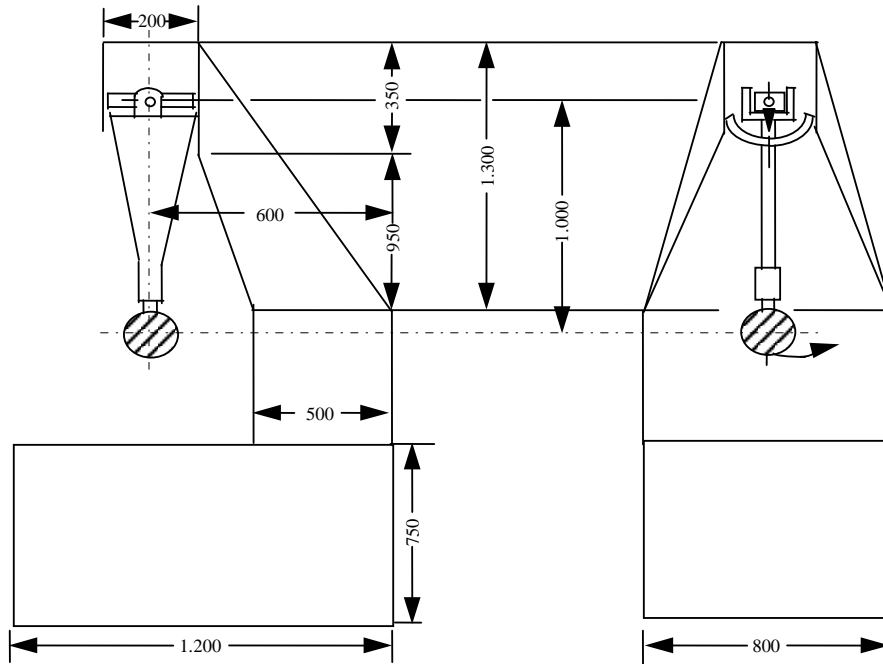

- 6.1.3.2.1.2. The centre of percussion of the pendulum coincides with the centre of the sphere, which forms the hammer. It is at a distance l from the axis of oscillation in the release plane, which is equal to $1\text{ m} \pm 5\text{ mm}$. The reduced mass of the pendulum is $m_o = 6.8 \pm 0.05$ kilograms. The relationship of m_o to the total mass m of the pendulum and to the distance d between the centre of gravity of the pendulum and its axis of rotation is expressed in the equation:

$$m_o = m \times \frac{d}{l}$$

- 6.1.3.2.2. Description of the test
- 6.1.3.2.2.1. The procedure used to clamp the mirror to the support shall be that recommended by the manufacturer of the device or, where appropriate, by the vehicle manufacturer.
- 6.1.3.2.2.2. Positioning of the mirror for the test:
- 6.1.3.2.2.2.1. Mirrors shall be positioned on the pendulum impact rig in such a way that the axes which are horizontal and vertical when the mirror is installed on a vehicle in accordance with the applicant's mounting instructions are in a similar position;
- 6.1.3.2.2.2.2. When a mirror is adjustable with respect to the base, the test position shall be that in which any pivoting device is least likely to operate, within the limits of adjustment provided by the applicant;
- 6.1.3.2.2.2.3. When the mirror has a device for adjusting its distance from the base, the device shall be set in the position in which the distance between the housing and the base is shortest;

- 6.1.3.2.2.4. When the reflecting surface is mobile in the housing, it shall be so adjusted that the upper corner, which is furthest from the vehicle, is in the position of greatest projection relative to the housing.
- 6.1.3.2.2.3. Except in the case of test 2 for interior mirrors (see paragraph 6.1.3.2.2.6.1. below), when the pendulum is in a vertical position the horizontal and longitudinal vertical planes passing through the centre of the hammer shall pass through the centre of the reflecting surface as defined in paragraph 2.1.1.11. of this Regulation The longitudinal direction of oscillation of the pendulum shall be parallel to the longitudinal median plane of the vehicle.
- 6.1.3.2.2.4. When, under the conditions governing adjustment laid down in paragraphs 6.1.3.2.2.1. and 6.1.3.2.2.2. above parts of the mirror limit the return of the hammer, the point of impact shall be displaced in a direction perpendicular to the axis of rotation or pivoting in question.

The displacement shall be no greater than is strictly necessary for the execution of the test; it shall be limited in such a way that:

- (a) Either the sphere delimiting the hammer remains at least tangential to the cylinder as defined in paragraph 6.1.1.6.;
- (b) Or the point of contact with the hammer is located at least 10 mm from the periphery of the reflecting surface.
- 6.1.3.2.2.5. The test consists in allowing the hammer to fall from a height corresponding to a pendulum angle of 60° from the vertical so that the hammer strikes the mirror at the moment when the pendulum reaches the vertical position.

6.1.3.2.2.6. The mirrors are subjected to impact under the following different conditions:

6.1.3.2.2.6.1. Interior mirrors

- (a) Test 1: The points of impact shall be as defined in paragraph 6.1.3.2.2.3. above. The impact shall be such that the hammer strikes the mirror on the reflecting surface side.
- (b) Test 2: Point of impact on the edge of the protective housing, such that the impact produced makes an angle of 45° with the plane of the reflecting surface and is situated in the horizontal plane passing through the centre of that surface. The impact shall occur on the reflecting surface side.

6.1.3.2.2.6.2. Exterior mirrors

- (a) Test 1: The point of impact shall be as defined in paragraph 6.1.3.2.2.3. or 6.1.3.2.2.4. above. The impact shall be such that the hammer strikes the mirror on the reflecting surface side.
- (b) Test 2: The point of impact shall be as defined in paragraph 6.1.3.2.2.3. or 6.1.3.2.2.4. above. The impact shall be such that the hammer strikes the mirror on the side opposite to the reflecting surface.

Where Class II or III rear-view mirrors are fixed to the same mounting as Class IV rear-view mirrors, the above-mentioned tests shall be executed on the lower mirror. Nevertheless, the Technical Service responsible for testing may repeat one or both of these tests on the upper mirror if this is less than 2 m from the ground.

6.1.3.2.3. Bending test on the protective housing attached to the stem (Class VII)

6.1.3.2.3.1. Description of test

The protective housing is placed horizontally in a device in such a way that it is possible to lock the attachment support adjusters firmly. In the direction of the largest dimension of the housing, the end closest to the point of attachment on the adjuster for the support shall be immobilized by a 15 mm-wide rigid stop covering the entire width of the housing.

At the other end, a stop identical to the one described above is placed on the housing so that the specified test load can be applied to it (Figure 2).

The end of the housing opposite to that where the force is exerted may be locked rather than held in position as shown in Figure 2.

Figure 2

Example of rear view mirror bending-test rig

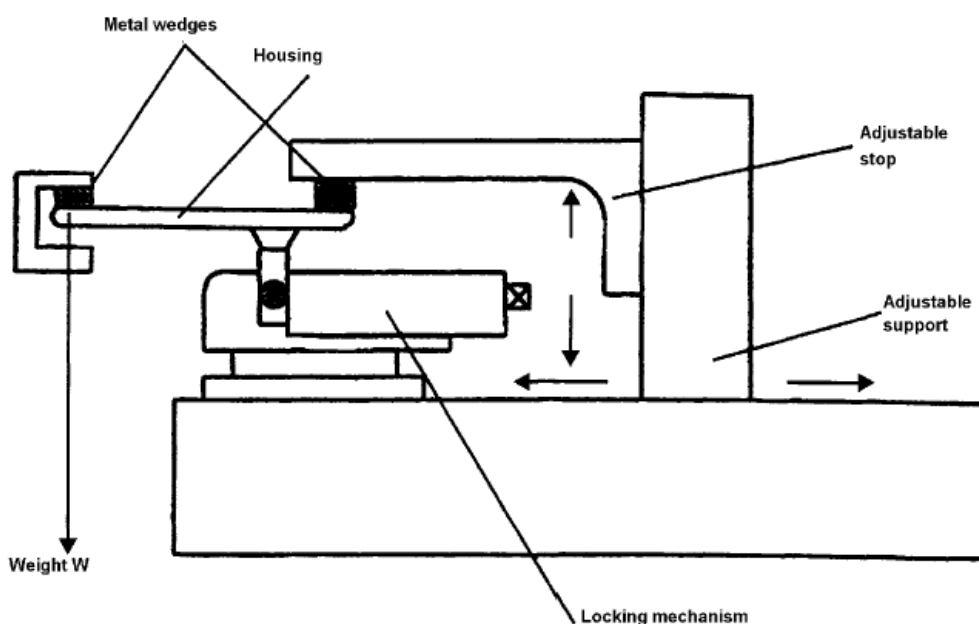

6.1.3.2.3.2. The test loading shall be 25 kilograms and shall be maintained for one minute.

6.1.3.3. Results of the tests

6.1.3.3.1. In the tests described in paragraph 6.1.3.2. above, the pendulum shall continue to swing after impact in such a way that the projection of the position assumed by the arm on the plane of release makes an angle of at least 20° with the vertical. The accuracy of measurement of the angle shall be within $\pm 1^\circ$.

6.1.3.3.1.1. This requirement is not applicable to mirrors stuck to the windscreen, in respect of which the requirement stipulated in paragraph 6.1.3.3.2. shall apply after the test.

6.1.3.3.1.2. The required angle to the vertical is reduced from 20° to 10° for all Class II and Class IV rear-view mirrors and for Class III rear-view mirrors which are attached to the same mounting as Class IV mirrors.

- 6.1.3.3.2. Should the mounting of the mirror break during the tests described in paragraph 6.1.3.2. above for mirrors stuck to the windscreen, the part remaining shall not project beyond the base by more than 10 mm and the configuration remaining after the test shall satisfy the conditions laid down in paragraph 6.1.1.3. of this Regulation.
- 6.1.3.3.3. The reflecting surface shall not break during the tests described in paragraph 6.1.3.2. However, breakage of the reflecting surface will be allowed if one of the following conditions is fulfilled:
 - 6.1.3.3.3.1. The fragments of glass still adhere to the back of the housing or to a surface firmly attached to the housing; partial separation of the glass from its backing is admissible provided that this does not exceed 2.5 mm on either side of the cracks. It is permissible for small splinters to become detached from the surface of the glass at the point of impact;
 - 6.1.3.3.3.2. The reflecting surface is made of safety glass.
- 6.2. Devices for indirect vision other than mirrors
 - 6.2.1. General requirements
 - 6.2.1.1. If adjustment by the user is needed, the device for indirect vision shall be adjustable without the use of tools.
 - 6.2.1.2. If a device for indirect vision can only render the total prescribed field of vision by scanning the field of vision, the total process of scanning, rendering and reset to its initial position together shall not take more than 2 seconds.
 - 6.2.2. Camera-monitor devices for indirect vision
 - 6.2.2.1. General requirements
 - 6.2.2.1.1. When the camera-monitor device for indirect vision is mounted on a plane surface, all parts, irrespective of the adjustment position of the device which are in potential, static contact with a sphere either 165 mm in diameter in the case of a monitor or 100 mm in diameter in the case of a camera, shall have a radius of curvature "c" of not less than 2.5 mm.
 - 6.2.2.1.2. Edges of fixing holes or recesses of which the diameter or longest diagonal is less than 12 mm are exempt from the radius requirements of paragraph 6.2.2.1.1. above provided that they are blunted.
 - 6.2.2.1.3. For parts of the camera and the monitor which are made of a material with a Shore A hardness of less than 60 and which are mounted on a rigid support, the requirements of paragraph 6.2.2.1.1. above shall only apply to the support.
 - 6.2.2.2. Functional requirements
 - 6.2.2.2.1. The camera shall function well in conditions in which sunlight falls on the camera. The saturated area, defined as the area in which the luminance contrast ratio ($C=L_w/L_b$) of a high contrast pattern falls below 2.0, shall not cover more than 15 per cent of the displayed image under the conditions of paragraphs 6.2.2.2.1.1. to 6.2.2.2.1.4. below.

In case the camera system shows dynamical changes in the blooming area during the test the maximum blooming area should fulfill the requirement.
 - 6.2.2.2.1.1. A black and white test pattern, having a minimum contrast ratio of 20 shall be positioned in front of the camera.

The test pattern shall be evenly illuminated at an illumination of $3,000 \pm 300$ Lx.

The test pattern shall be medium gray on average and cover the complete area viewed by the camera; the camera shall view no other objects than the test pattern.

- 6.2.2.2.1.2. The camera shall be hit by a (simulated sun) light of 40 kLx, spanning an angle between 0.6 and 0.9 degrees with an elevation angle of 10 degrees (directly or indirectly via a mirror) removed from the optical axis of the sensor.

The light source shall:

- (a) Have a spectrum D65 with a tolerance of $\pm 1,500$ K;
- (b) Be homogeneous in space and time within a tolerance of 2 kLx.

The emission of the light source in infrared shall be negligible.

- 6.2.2.2.1.3. There shall be no ambient illumination of the monitor during the test.

- 6.2.2.2.1.4. An example of the set-up is given in the Figure A below.

Figure A

Diagram of the blooming measurement set-up

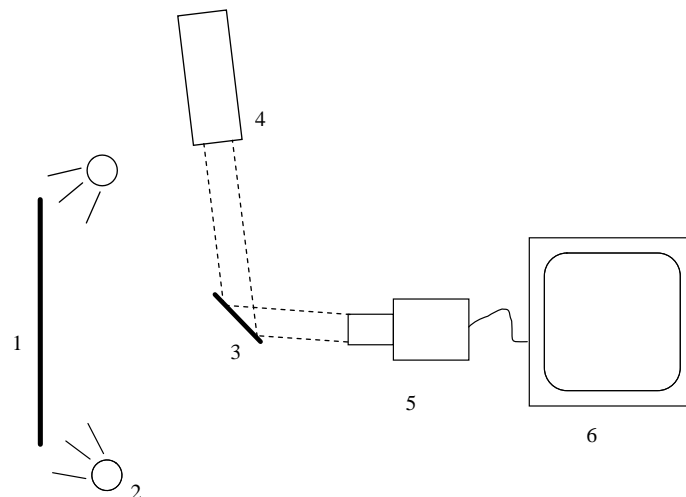

- 1: Black and white test pattern.
- 2: Lamps to make the test pattern evenly illuminated.
- 3: Mirror.
- 4: High intensity light.
- 5: Camera.
- 6: Monitor.

- 6.2.2.2.2. The monitor shall render a minimum contrast under various light conditions as specified by ISO 15008:2003.

- 6.2.2.2.3. It shall be possible to adjust the average luminance of the monitor either manually or automatically to the ambient conditions.

- 6.2.2.2.4. The measurements for the luminance contrast of the monitor shall be carried out according to ISO 15008:2009.

6.2.3. Other devices for indirect vision

It has to be proved that the device meets the following requirements:

6.2.3.1. The device shall perceive the visual spectrum and shall always render this image without the need for interpretation into the visual spectrum.

6.2.3.2. The functionality shall be guaranteed under the circumstances of use in which the system shall be put into service. Depending on the technology used in obtaining images and presenting them paragraph 6.2.2.2. above shall be entirely or partly applicable. In other cases this can be achieved by establishing and demonstrating by means of system sensitivity analogous to paragraph 6.2.2.2. above that a function is ensured that is comparable to or better than what is required for and by demonstrating that a functionality is guaranteed that is equivalent or better than that required for mirror- or camera-monitor type devices for indirect vision.

7. Modification of the type of device for indirect vision and extension of approval

7.1. Every modification to an existing type of device for indirect vision including its connection to the bodywork shall be notified to the Type Approval Authority which approved the type of device for indirect vision. The Type Approval Authority shall then either:

- (a) Decide, in consultation with the manufacturer, that a new type-approval is to be granted, or
- (b) Apply the procedure contained in paragraph 7.1.1. (Revision) and, if applicable, the procedure contained in paragraph 7.1.2. (Extension).

7.1.1. Revision

When particulars recorded in the information folder have changed and the Type Approval Authority considers that the modifications made are unlikely to have an appreciable adverse effect and that in any case the device for indirect vision still complies with the requirements, the modification shall be designated a "revision".

In such a case, the Type Approval Authority shall issue the revised pages of the information folder as necessary, marking each revised page to show clearly the nature of the modification and the date of re-issue. A consolidated, updated version of the information folder, accompanied by a detailed description of the modification, shall be deemed to meet this requirement.

7.1.2. Extension

The modification shall be designated an "extension" if, in addition to the change of the particulars recorded in the information folder,

- (a) Further inspections or tests are required, or
- (b) Any information on the communication document (with the exception of its attachments) has changed, or
- (c) Approval to a later series of amendments is requested after its entry into force.

- 7.2. Confirmation or refusal of approval, specifying the alterations shall be communicated by the procedure specified in paragraph 5.3. above to the Parties to the Agreement which apply this Regulation. In addition, the index to the information package, attached to the communication document, shall be amended accordingly to show the date of the most recent revision or extension.
- 7.3. (Reserved)
- 7.4. The Type Approval Authority issuing the extension of approval shall assign a series number to each communication form drawn up for such an extension.

8. Conformity of production

- 8.1. The conformity of production procedure shall comply with those set out in the Agreement, Appendix 2 (E/ECE/324-E/ECE/TRANS/505/Rev.2).
- 8.2. Every device for indirect vision approved under this Regulation shall be so manufactured as to conform to the type approved by meeting the requirements set out in paragraph 6. above.

9. Penalties for non-conformity of production

- 9.1. The approval granted in respect of a type of device for indirect vision pursuant to this Regulation may be withdrawn if the requirement laid down in paragraph 8.1. above is not complied with or if the type of device for indirect vision did not satisfy the requirements prescribed in paragraph 8.2. above.
- 9.2. If a Party to the Agreement which applies this Regulation withdraws an approval it has previously granted, it shall forthwith so notify the other Contracting Parties applying this Regulation by means of a copy of the communication form bearing at the end, in large letters, the signed and dated annotation "APPROVAL WITHDRAWN".

10. Production definitively discontinued

If the holder of the approval completely ceases to manufacture a type of device for indirect vision approved in accordance with this Regulation, he shall so inform the Type Approval Authority which granted the approval. Upon receiving the relevant communication that authority shall inform thereof the other Parties to the Agreement applying this Regulation by means of a copy of the approval form bearing at the end, in large letters, the signed and dated annotation "PRODUCTION DISCONTINUED".

11. Names and addresses of Technical Services responsible for conducting approval tests, and of Type Approval Authorities

The Parties to the Agreement applying this Regulation shall communicate to the United Nations Secretariat the names and addresses of the Technical Services responsible for conducting approval tests and of the Type Approval Authorities which grant approval and to which forms certifying approval or refusal or extension or withdrawal of approval, issued in other countries, are to be sent.

II. Installation of devices for indirect vision

12. Definitions

For the purpose of this Regulation:

- 12.1. "The driver's ocular points" means two points 65 mm apart and 635 mm vertically above point R of the driver's seat as defined in Annex 8. The straight line joining these points runs perpendicular to the vertical longitudinal median plane of the vehicle. The centre of the segment joining the two ocular points is in a vertical longitudinal plane which shall pass through the centre of the driver's designated seating position, as specified by the vehicle manufacturer.
- 12.2. "Ambinocular vision" means the total field of vision obtained by the superimposition of the monocular fields of the right eye and the left eye (see Figure 3 below).

Figure 3

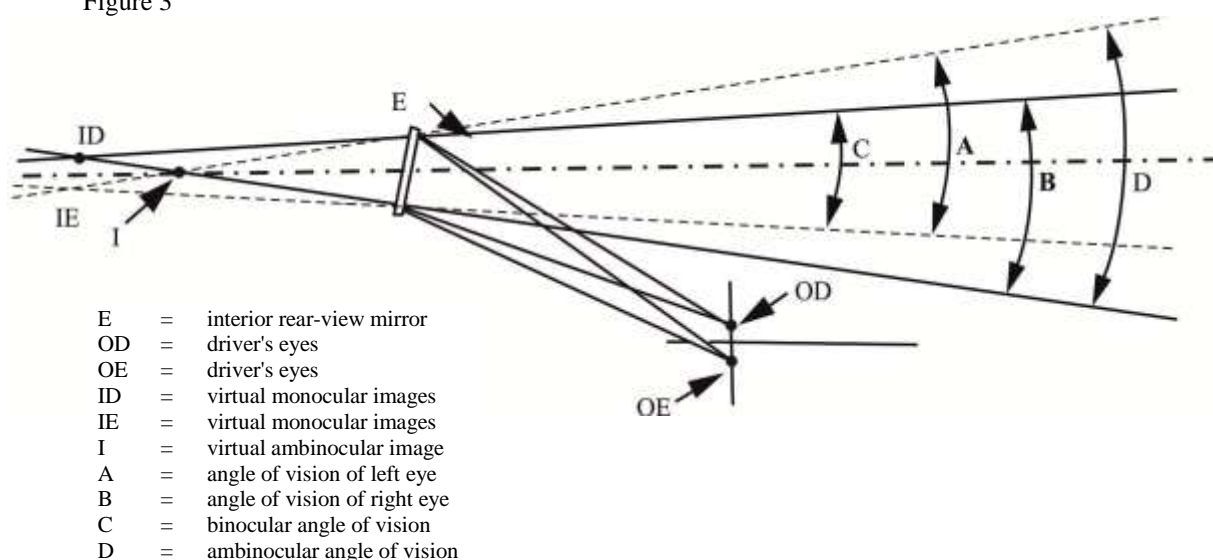

- 12.3. "Type of vehicle as regards indirect vision" means motor vehicles which are identical in respect of the following basic features:
- 12.3.1. Type of device for indirect vision;
- 12.3.2. The bodywork features which reduce the field of vision;
- 12.3.3. The coordinates of point R (where applicable);
- 12.3.4. The prescribed positions, and type-approval markings of compulsory and (if fitted) optional devices for indirect vision.
- 12.4. "Vehicles of categories L_2 , L_5 , M_1 , M_2 , M_3 , N_1 , N_2 and N_3 " means those defined in the Consolidated Resolution on the Construction of Vehicles (R.E.3), (document TRANS/WP.29/78/Rev.2, para. 2).
- 12.5. "Forward control" means a configuration in which more than half of the engine length is rearward of the foremost point of the windshield base and the steering wheel hub in the forward quarter of the vehicle length.

13. Application for approval

- 13.1. The application for approval of a vehicle type with regard to the installation of devices for indirect vision shall be submitted by the vehicle manufacturer or by his duly accredited representative.
- 13.2. A model of information document is shown in Annex 2.
- 13.3. A vehicle representative of the vehicle type to be approved shall be submitted to the Technical Service responsible for conducting the approval tests.
- 13.4. The Type Approval Authority shall verify the existence of satisfactory arrangements for ensuring effective checks on conformity of production before type-approval is granted.

14. Approval

- 14.1. If the vehicle type submitted for approval in accordance with paragraph 13. above meets the requirements of paragraph 15. of this Regulation, approval shall be granted.
- 14.2. An approval number shall be assigned to each type approved. Its first two digits (at present 04) shall indicate the series of amendments incorporating the most recent or technical amendments made to the Regulation at the time of issue of the approval. The same Contracting Party shall not assign the same number to another vehicle type.
- 14.3. Notice of approval or of refusal or of extension or withdrawal of approval of a vehicle type pursuant to this Regulation shall be communicated to the Parties to the Agreement which apply this Regulation by means of a form conforming to the model in Annex 4 to this Regulation.

15. Requirements

- 15.1. General
 - 15.1.1. The compulsory and optional devices for indirect vision, set out in the table under paragraph 15.2.1.1. below, installed on the vehicle shall be of a type approved under this Regulation.
 - 15.1.2. Mirrors and other devices for indirect vision shall be fitted in such a way that the mirror or other device does not move so as significantly to change the field of vision as measured or vibrate to an extent which would cause the driver to misinterpret the nature of the image perceived.
 - 15.1.3. The conditions laid down in paragraph 15.1.2. above shall be maintained when the vehicle is moving at speeds of up to 80 per cent of its maximum design speed, but not exceeding 150 km/h.
 - 15.1.4. The fields of vision defined below shall be established using ambinoocular vision, the eyes being at the "driver's ocular points" as defined in paragraph 12.1. above. The fields of vision shall be determined when the vehicle is in running order as defined in the consolidated Resolution on the Construction of vehicles (R.E.3) (ECE/TRANS/WP.29/78/Rev.2, para. 2.2.5.4.), plus for M₁ and N₁ vehicles one front seat passenger (75 kg).

When established through windows, the glazing shall have a total light transmission factor in accordance with Regulation No. 43, Annex 21.

15.2. Mirrors

15.2.1. Number

15.2.1.1. Minimum number of compulsory mirrors

15.2.1.1.1. The fields of vision prescribed in paragraph 15.2.4. below shall be obtained from the minimum number on mandatory mirrors set out in the following table. Where the presence of a mirror is not requested on a mandatory base, this means that no other system for indirect vision can be requested on a mandatory base.

Vehicle category	Interior mirror		Exterior mirrors			
	Interior mirror Class I	Main mirror (large) Class II	Main mirror (small) Class III	Wide-angle mirror Class IV	Close-proximity mirror Class V	Front mirror Class VI
M ₁	Compulsory Unless the vehicle is fitted with anything other than safety glazing material in the field of vision prescribed in paragraph 15.2.4.1.	Optional	Compulsory 1 on the driver's side and 1 on the passenger's side Class II mirrors may be fitted as an alternative.	Optional 1 on the driver's side and/or 1 on the passenger's side	Optional 1 on the driver's side and 1 on the passenger's side (both shall be fitted at least 2 m above the ground)	Optional (shall be fitted at least 2 m above the ground)
M ₂	Optional (no requirements for the field of view)	Compulsory 1 on the driver's side and 1 on the passenger's side	Not permitted	Optional 1 on the driver's side and/or 1 on the passenger's side	Optional 1 on the driver's side and 1 on the passenger's side (both shall be fitted at least 2 m above the ground)	Optional (shall be fitted at least 2 m above the ground)
M ₃	Optional (no requirements for the field of view)	Compulsory 1 on the driver's side and 1 on the passenger's side	Not permitted	Optional 1 on the driver's side and/or 1 on the passenger's side	Optional 1 on the driver's side and 1 on the passenger's side (both shall be fitted at least 2 m above the ground)	Optional (shall be fitted at least 2 m above the ground)
N ₁	Compulsory Unless the vehicle is fitted with anything other than safety glazing material in the field of vision prescribed in paragraph 15.2.4.1.	Optional	Compulsory 1 on the driver's side and 1 on the passenger's side Class II mirrors may be fitted as an alternative.	Optional 1 on the driver's side and/or 1 on the passenger's side	Optional 1 on the driver's side and 1 on the passenger's side (both shall be fitted at least 2 m above the ground)	Optional (shall be fitted at least 2 m above the ground)

Vehicle category	Interior mirror		Exterior mirrors			
	Interior mirror Class I	Main mirror (large) Class II	Main mirror (small) Class III	Wide-angle mirror Class IV	Close-proximity mirror Class V	Front mirror Class VI
N ₂ ≤ 7,5 t	Optional (no requirements for the field of view)	Compulsory 1 on the driver's side and 1 on the passenger's side	Not permitted	Compulsory For both sides if a Class V mirror can be fitted Optional For both sides together if not In addition according to paragraphs 15.2.4.5.6. to 15.2.4.5.11. for vehicles with a mounting height of the Class V mirror of not less than 2.4 m (see paragraph 15.2.4.5.12.): the required field of vision (paragraphs 15.2.4.5.6. to 15.2.4.5.9.) may be viewed using a combination of direct view and indirect vision devices (of Classes IV, V, VI).	Compulsory (see paragraphs 15.2.2.7. and 15.2.4.5.5.) 1 on the passenger's side Optional 1 on the driver's side (both shall be fitted at least 2 m above the ground). A tolerance of +10 cm may be applied In addition according to paragraphs 15.2.4.5.6. to 15.2.4.5.11. for vehicles with a mounting height of the Class V mirror of not less than 2.4 m (see paragraph 15.2.4.5.12.): the required field of vision (paragraphs 15.2.4.5.6. to 15.2.4.5.9.) may be viewed using a combination of direct view and indirect vision devices (of Classes IV, V, VI).	Optional 1 front mirror (shall be fitted at least 2 m above the ground) In addition according to paragraphs 15.2.4.5.6. to 15.2.4.5.11. for vehicles with a mounting height of the Class V mirror of not less than 2.4 m (see paragraph 15.2.4.5.12.): the required field of vision (paragraphs 15.2.4.5.6. to 15.2.4.5.9.) may be viewed using a combination of direct view and indirect vision devices (of Classes IV, V, VI).

Vehicle category	Interior mirror		Exterior mirrors			
	Interior mirror Class I	Main mirror (large) Class II	Main mirror (small) Class III	Wide-angle mirror Class IV	Close-proximity mirror Class V	Front mirror Class VI
N ₂ > 7,5 t	Optional (no requirements for the field of view)	Compulsory 1 on the driver's side and 1 on the passenger's side	Not permitted	Compulsory 1 on the driver's side and 1 on the passenger's side In addition according to paragraphs 15.2.4.5.6. to 15.2.4.5.11. for vehicles with a mounting height of the Class V mirror of not less than 2.4 m (see paragraph 15.2.4.5.12.): the required field of vision (paragraphs 15.2.4.5.6. to 15.2.4.5.9.) may be viewed using a combination of direct view and indirect vision devices (of Classes IV, V, VI).	Compulsory (see paragraph 15.2.2.7. and 15.2.4.5.5) 1 on the passenger's side Optional 1 on Driver's side (both shall be fitted at least 2 m above the ground) In addition according to paragraphs 15.2.4.5.6. to 15.2.4.5.11. for vehicles with a mounting height of the Class V mirror of not less than 2.4 m (see paragraph 15.2.4.5.12.): the required field of vision (paragraphs 15.2.4.5.6. to 15.2.4.5.9.) may be viewed using a combination of direct view and indirect vision devices (of Classes IV, V, VI).	Compulsory (see paragraph 15.2.1.1.2 1. front mirror (shall be fitted at least 2 m above the ground) In addition according to paragraphs 15.2.4.5.6. to 15.2.4.5.11. for vehicles with a mounting height of the Class V mirror of not less than 2.4 m (see paragraph 15.2.4.5.12.): the required field of vision (paragraphs 15.2.4.5.6. to 15.2.4.5.9.) may be viewed using a combination of direct view and indirect vision devices (of Classes IV, V, VI).

Vehicle category	Interior mirror		Exterior mirrors			
	Interior mirror Class I	Main mirror (large) Class II	Main mirror (small) Class III	Wide-angle mirror Class IV	Close-proximity mirror Class V	Front mirror Class VI
N ₃	Optional (no requirements for the field of view)	Compulsory 1 on the driver's side and 1 on the passenger's side	Not permitted	Compulsory 1 on the driver's side and 1 on the passenger's side In addition according to paragraphs 15.2.4.5.6. to 15.2.4.5.11. for vehicles with a mounting height of the Class V mirror of not less than 2.4 m (see paragraph 15.2.4.5.12.): the required field of vision (paragraphs 15.2.4.5.6. to 15.2.4.5.9.) may be viewed using a combination of direct view and indirect vision devices (of Classes IV, V, VI).	Compulsory (see paragraph 15.2.2.7. and 15.2.4.5.5) 1 on the passenger's side Optional 1 on driver's side (both shall be fitted at least 2 m above the ground) In addition according to paragraphs 15.2.4.5.6. to 15.2.4.5.11. for vehicles with a mounting height of the Class V mirror of not less than 2.4 m (see paragraph 15.2.4.5.12.): the required field of vision (paragraphs 15.2.4.5.6. to 15.2.4.5.9.) may be viewed using a combination of direct view and indirect vision devices (of Classes IV, V, VI).	Compulsory (see paragraph 15.2.1.1.2 1. front mirror (shall be fitted at least 2 m above the ground) In addition according to paragraphs 15.2.4.5.6. to 15.2.4.5.11. for vehicles with a mounting height of the Class V mirror of not less than 2.4 m (see paragraph 15.2.4.5.12.): the required field of vision (paragraphs 15.2.4.5.6. to 15.2.4.5.9.) may be viewed using a combination of direct view and indirect vision devices (of Classes IV, V, VI).

15.2.1.1.2. In case the described field of vision of a front mirror prescribed in paragraph 15.2.4.6. below and/or a close proximity mirror described in paragraph 15.2.4.5. below can be obtained by another device for indirect vision that is approved according to paragraph 6.2. of this Regulation and that is installed according to paragraph 15. above, this device can be used instead of the relevant mirror or mirrors.

In case a camera/monitor device is used, the monitor shall exclusively show:

- (a) The field of vision prescribed in paragraph 15.2.4.5. below when the close proximity mirror has been substituted;
- (b) The field of vision prescribed in paragraph 15.2.4.6. below when the front mirror has been substituted while the vehicle is moving forward with a speed of up to 10 km/h; or
- (c) Simultaneously the fields of vision prescribed in paragraphs 15.2.4.5. and 15.2.4.6. below when the close proximity mirror and the front mirror have been substituted. In the case where the vehicle is moving forward at a higher speed than 10 km/h or moving backwards, the monitor may be used for other information, provided that the field of vision prescribed in paragraph 15.2.4.5. below is permanently displayed.

15.2.1.1.3. Rear view mirrors required for L-category vehicles with body work

<i>Category of vehicle</i>	<i>Interior mirror (Class I)</i>	<i>Main exterior mirror(s) (Classes III and VII)</i>
L category motor vehicles fitted with bodywork which partly or wholly encloses the driver	1 ¹	1, if there is an interior mirror; 2, if there is not an interior mirror
¹ No interior rear-view mirror is required if the visibility conditions referred to in paragraph 15.2.5.4.1. below cannot be met. In this case two exterior rear-view mirrors are required, one on the left and one on the right hand side of the vehicle.		

Where a single exterior rear view mirror is fitted this shall be located on the left hand side of the vehicle in those countries where the traffic drives on the right and on the right hand side of the vehicle in those countries where the traffic drives on the left.

15.2.1.1.4. Optional rear-view mirrors for L-category vehicles

The fitting of an exterior rear-view mirror on the side of the vehicle opposite to that of the mandatory rear-view mirror referred to in paragraph 15.2.1.1.3. above, is permissible. The rear-view mirror shall meet the requirements of this Regulation.

15.2.1.2. The provisions of this Regulation do not apply to the surveillance mirrors defined in paragraph 2.1.1.3. of this Regulation. Nevertheless, the exterior surveillance mirrors shall be mounted at least 2 m above the ground when the vehicle is under a load corresponding to its maximum technical permissible mass.

15.2.2. Position

15.2.2.1. Mirrors shall be so placed that the driver, when sitting on the driving seat in a normal driving position, has a clear view of the road to the rear, side(s) or front of the vehicle.

- 15.2.2.2. Exterior mirrors shall be visible through the side windows or through the portion of the windscreen that is swept by the windscreen wiper. Nevertheless, for design reasons, this last provision (i.e. the provisions relating the cleaned part of the windscreen) shall not apply to:
- (a) Exterior mirrors on the passenger side and optional exterior mirrors on the driver side of vehicles of categories M₂ and M₃;
 - (b) Class VI mirrors.
- 15.2.2.3. In the case of any vehicle, which is in chassis/cab form when the field of vision is measured, the minimum and maximum body widths shall be stated by the manufacturer and, if necessary, simulated by dummy headboards. All vehicles and mirror configurations taken into consideration during the tests shall be shown on the type-approval certificate for a vehicle with regard to the installation of mirrors (see Annex 4).
- 15.2.2.4. The prescribed exterior mirror on the driver's side of the vehicle shall be so located that an angle of not more than 55° is formed between the vertical longitudinal median plane of the vehicle and the vertical plane passing through the centre of the mirror and through the centre of the straight line 65 mm long which joins the driver's two ocular points.
- 15.2.2.5. Mirrors shall not project beyond the external bodywork of the vehicle substantially more than is necessary to comply with the requirements concerning fields of vision laid down in paragraph 15.2.4. below.
- 15.2.2.6. Where the lower edge of an exterior mirror is less than 2 m above the ground when the vehicle is loaded to its technically permissible maximum laden mass, this mirror shall not project more than 250 mm beyond the overall width of the vehicle measured without mirrors.
- 15.2.2.7. Class V and Class VI mirrors shall be mounted on vehicles in such a way that, regardless of their position after adjustment, no part of these mirrors or their holders is less than 2 m from the ground when the vehicle is under a load corresponding to its technically permissible maximum laden mass.
- These mirrors shall not, however, be mounted on vehicles the cab height of which is such as to prevent compliance with this requirement. In this case an other device for indirect vision is not requested.
- 15.2.2.8. Subject to the requirements of paragraphs 15.2.2.5., 15.2.2.6. and 15.2.2.7. above, mirrors may project beyond the permissible maximum widths of vehicles.
- 15.2.2.9. All Class VII mirrors shall be attached in such a way that they remain in a stable position under normal vehicle driving conditions.
- 15.2.3. Adjustment
- 15.2.3.1. The interior mirror shall be capable of being adjusted by the driver from his driving position.
- 15.2.3.2. The exterior mirror situated on the driver's side shall be capable of being adjusted from inside the vehicle while the door is closed, although the window may be open. The mirror may, however, be locked in position from the outside.
- 15.2.3.3. The requirements of paragraph 15.2.3.2. above do not apply to exterior mirrors which, after having been knocked out of alignment, can be returned to their former position without the need for adjustment.

- 15.2.4. Fields of vision
- 15.2.4.1. Interior rear-view mirror (Class I)

The field of vision shall be such that the driver can see at least a 20 m wide, flat, horizontal portion of the road centred on the vertical longitudinal median plane of the vehicle and extending from 60 m behind the driver's ocular points (Figure 4) to the horizon.

Figure 4
Field of vision of Class I mirror

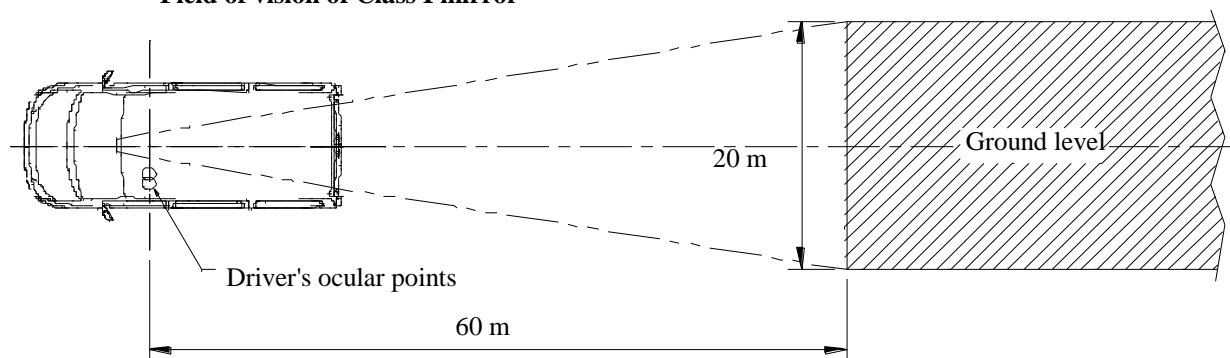

- 15.2.4.2. Main exterior rear-view mirrors Class II
- 15.2.4.2.1. Exterior rear-view mirror on the driver's side

The field of vision shall be such that the driver can see at least a 5 m wide, flat, horizontal portion of the road, which is bounded by a plane which is parallel to the median longitudinal vertical plane and passing through the outermost point of the vehicle on the driver's side of the vehicle and extends from 30 m behind the driver's ocular points to the horizon.

In addition, the road shall be visible to the driver over a width of 1 m, which is bounded by a plane parallel to the median longitudinal vertical plane and passing through the outermost point of the vehicle starting from a point 4 m behind the vertical plane passing through the driver's ocular points (see Figure 5).

- 15.2.4.2.2. Exterior rear-view mirror on the passenger's side

The field of vision shall be such that the driver can see at least a 5 m wide, flat, horizontal portion of the road, which is bounded on the passenger's side by a plane parallel to the median longitudinal vertical plane of the vehicle and passing through the outermost point of the vehicle on the passenger's side and which extends from 30 m behind the driver's ocular points to the horizon.

In addition, the road shall be visible to the driver over a width of 1 m, which is bounded by a plane parallel to the median longitudinal vertical plane and passing through the outermost point of the vehicle starting from a point 4 m behind the vertical plane passing through the driver's ocular points (see Figure 5).

Figure 5
Field of vision of Class II mirrors

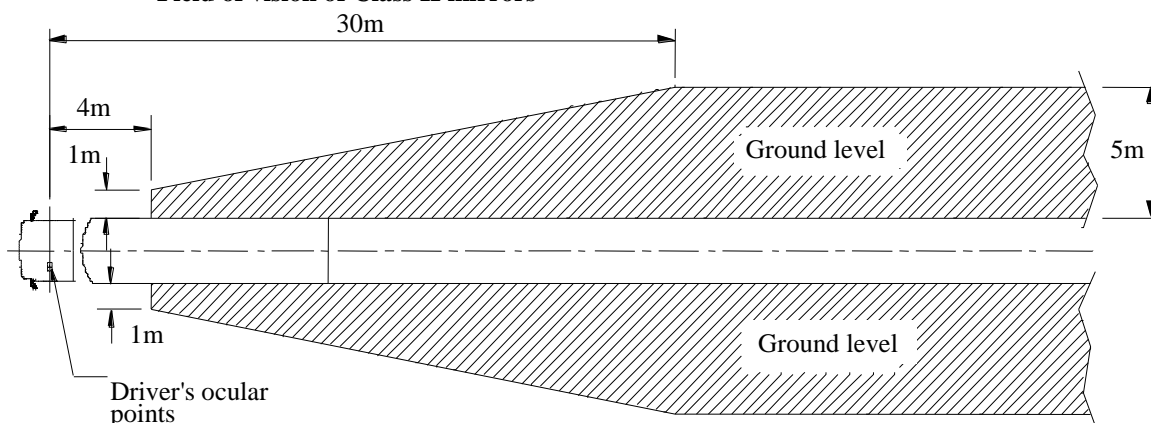

15.2.4.3. Main exterior rear-view mirrors Class III

15.2.4.3.1. Exterior rear-view mirror on the driver's side

The field of vision shall be such that the driver can see at least a 4 m wide, flat, horizontal portion of the road, which is bounded by a plane parallel to the median longitudinal vertical plane and passing through the outermost point of the vehicle on the driver's side of the vehicle and extends from 20 m behind the driver's ocular points to the horizon (see Figure 6).

In addition, the road shall be visible to the driver over a width of 1 m, which is bounded by a plane parallel to the median longitudinal vertical plane and passing through the outermost point of the vehicle starting from a point 4 m behind the vertical plane passing through the driver's ocular points.

15.2.4.3.2. Exterior rear-view mirror on the passenger's side

The field of vision shall be such that the driver can see at least a 4 m wide flat, horizontal portion of the road which is bounded by a plane parallel to the median longitudinal vertical plane passing through the outermost point of the vehicle on the passenger's side and which extends from 20 m behind the driver's ocular points to the horizon (see Figure 6).

In addition, the road shall be visible to the driver over a width of 1 m, which is bounded by a plane parallel to the median longitudinal vertical plane and passing through the outermost point of the vehicle starting from a point 4 m behind the vertical plane passing through the driver's ocular points.

Figure 6
Field of vision of Class III mirrors

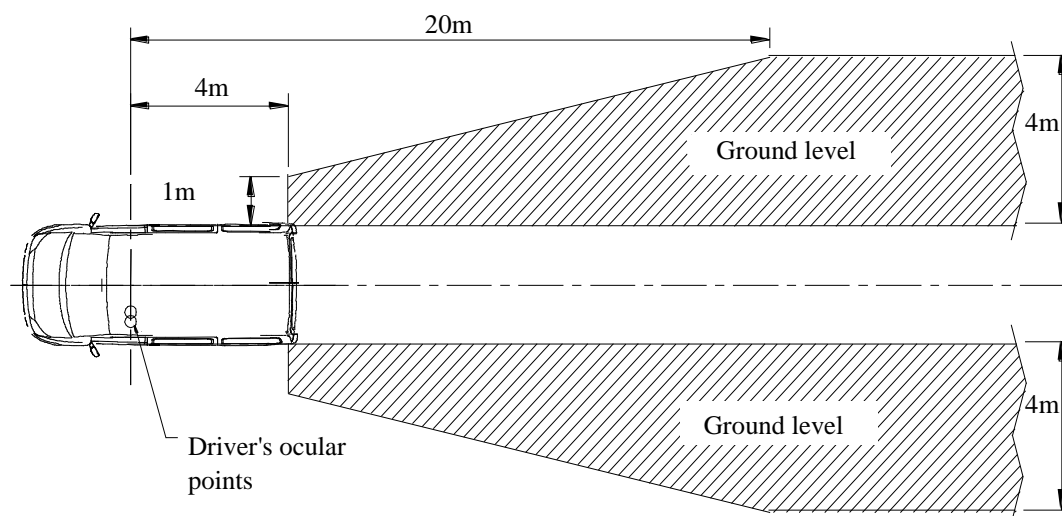

15.2.4.4. "Wide-angle" exterior mirror (Class IV)

15.2.4.4.1. "Wide-angle" exterior mirror on the driver's side

The field of vision shall be such that the driver can see at least a 15 m wide, flat, horizontal portion of the road, which is bounded by a plane parallel to the median longitudinal vertical plane of the vehicle and passing through the outermost point of the vehicle on the driver's side and which extends from at least 10 m to 25 m behind the driver's ocular points.

In addition, the road shall be visible to the driver over a width of 4.5 m, which is bounded by a plane parallel to the median longitudinal vertical plane and passing through the outermost point of the vehicle starting from a point 1.5 m behind the vertical plane passing through the driver's ocular points (see Figure 7).

15.2.4.4.2. "Wide-angle" exterior mirror on the passenger's side

The field of vision shall be such that the driver can see at least a 15 m wide, flat, horizontal portion of the road, which is bounded by a plane parallel to the median longitudinal vertical plane of the vehicle and passing through the outermost point of the vehicle on the passenger's side and which extends from at least 10 m to 25 m behind the driver's ocular points.

In addition, the road shall be visible to the driver over a width of 4.5 m, which is bounded by a plane parallel to the median longitudinal vertical plane and passing through the outermost point of the vehicle starting from a point 1.5 m behind the vertical plane passing through the driver's ocular points (see Figure 7).

Figure 7
Field of vision of Class IV wide-angle mirrors

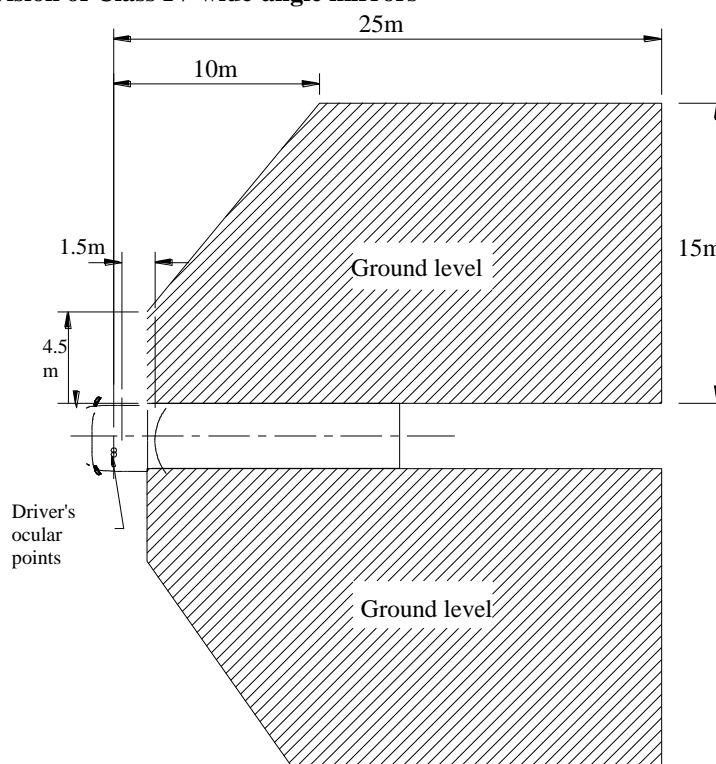

15.2.4.5. "Close-proximity" exterior mirror (Class V)

The field of vision shall be such that the driver can see a flat horizontal portion of the road along the side of the vehicle, bounded by the following vertical planes (see Figures 8a and 8b):

- 15.2.4.5.1. The plane parallel to the median longitudinal vertical plane of the vehicle which passes through the outermost point of the vehicle cab on the passenger's side;
- 15.2.4.5.2. In the transverse direction, the parallel plane passing at a distance of 2 m in front of the plane mentioned in paragraph 15.2.4.5.1. above.
- 15.2.4.5.3. To the rear, the plane parallel to the vertical plane passing through the driver's ocular points and situated at a distance of 1.75 m behind that plane;
- 15.2.4.5.4. To the front, the plane parallel to the vertical plane passing through the driver's ocular points and situated at a distance of 1 m in front of that plane. If the vertical transverse plane passing through the leading edge of the vehicle bumper is less than 1 m in front of the vertical plane passing through the driver's ocular points, the field of vision shall be limited to that plane.
- 15.2.4.5.5. In case the field of vision described in Figures 8a and 8b can be perceived through the combination of the field of vision from a Class IV wide-angle mirror and that of a Class VI front mirror, the installation of a Class V close proximity mirror is not compulsory.

Figures 8a and 8b
Field of vision of Class V close-proximity mirror

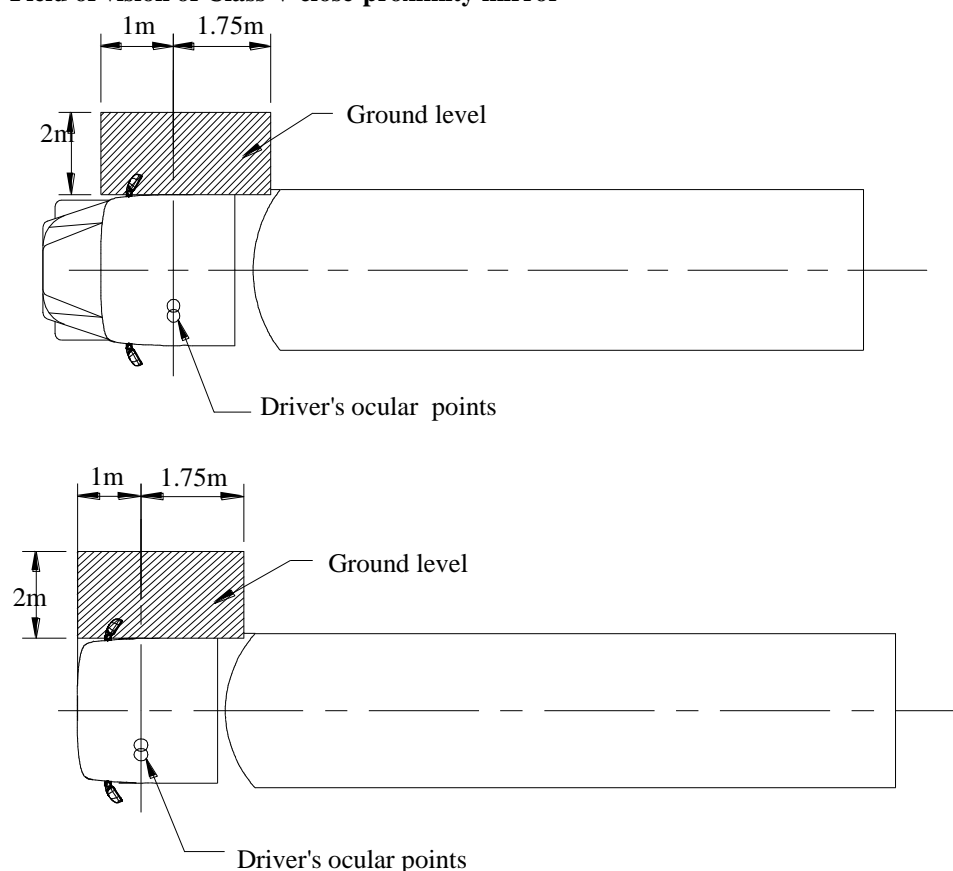

- 15.2.4.5.6. On the passenger side only, the field of vision shall also be such that the driver can see a flat horizontal portion of the road along the side of the vehicle which is outside the field defined in paragraphs 15.2.4.5.1. to 15.2.4.5.4. above but within the field bounded by the following vertical planes; the front of this field of vision may be rounded off with a radius of 2,000 mm (see Figures 8c and 8d):
- 15.2.4.5.7. In the transverse direction, the parallel plane passing at a distance of 4.5 m in front of the plane mentioned in paragraph 15.2.4.5.1. above.
- 15.2.4.5.8. To the rear, the plane parallel to the vertical plane passing through the driver's ocular points and situated at a distance of 1.75 m behind that plane.
- 15.2.4.5.9. To the front, the plane parallel to the vertical plane passing through the driver's ocular points and situated at a distance of 3 m in front of that plane. This field of vision may be partially provided by a front mirror (Class VI).
- 15.2.4.5.10. The field of vision prescribed in paragraphs 15.2.4.5.6. to 15.2.4.5.9. above may be partially provided by a "wide-angle" exterior mirror (Class IV) or a combination of a close-proximity exterior mirror (Class V) and a front mirror (Class VI).
- 15.2.4.5.11. The area prescribed in paragraphs 15.2.4.5.6. to 15.2.4.5.9. above may be viewed using a combination of direct view and indirect vision devices.

15.2.4.5.12. Paragraphs 15.2.4.5.6. to 15.2.4.5.9. above shall not apply to a vehicle where no part of the mirror, or its holder, is less than 2.4 m above the ground, regardless of its position after adjustment.

15.2.4.5.13. Paragraphs 15.2.4.5.6. to 15.2.4.5.9. above shall not apply to a vehicle of category M₂ or M₃.

Figures 8c and 8d

Larger field of vision on the passenger side

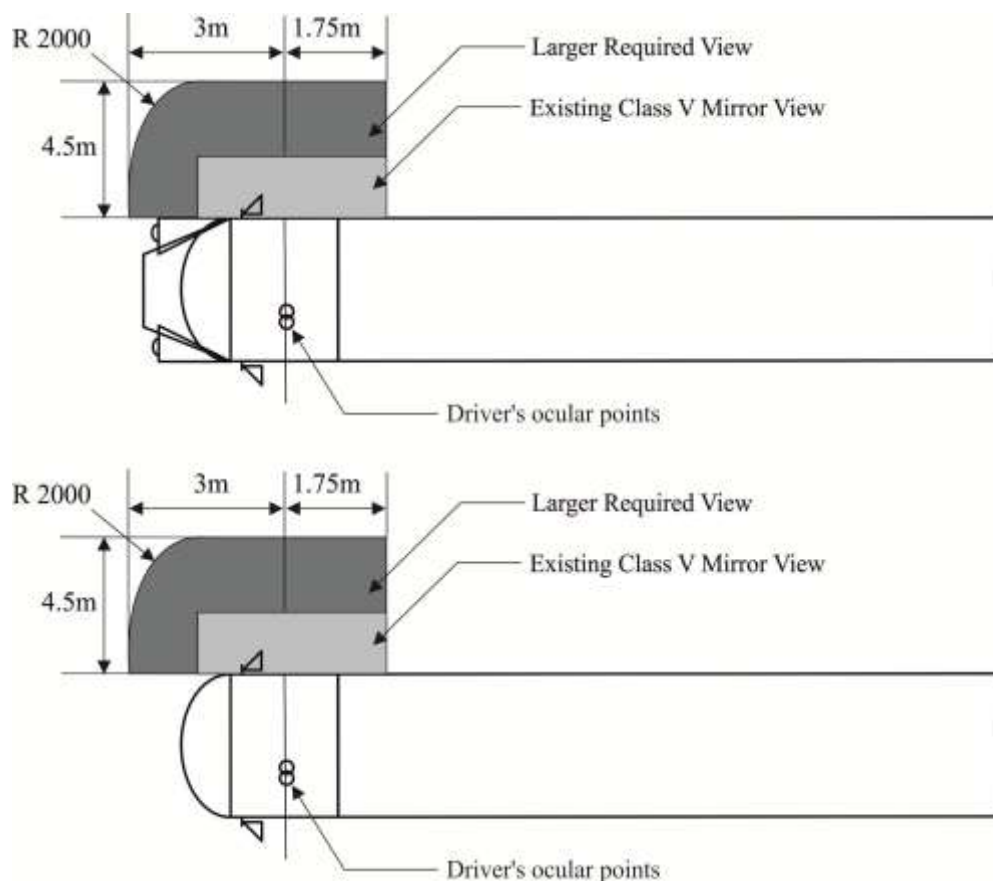

15.2.4.6. Front mirror (Class VI)

15.2.4.6.1. The field of vision shall be such that the driver can see at least a flat horizontal portion of the road, which is bounded by:

- (a) A transverse vertical plane through the outermost point of the front of the vehicle;
- (b) A transverse vertical plane 2,000 mm in front of the plane defined in (a);
- (c) A longitudinal vertical plane parallel to the longitudinal vertical median plane going through the outermost side of the vehicle at the driver's side; and
- (d) A longitudinal vertical plane parallel to the longitudinal vertical median plane 2,000 mm outside the outermost side of the vehicle opposite to the driver's side.

The front of this field of vision opposite to the driver's side may be rounded off with a radius of 2,000 mm (see Figure 9).

For the defined field of vision, see also paragraph 15.2.4.9.2. below.

The provisions for front mirrors are compulsory for forward controlled (as defined in paragraph 12.5. of this Regulation) vehicles of categories $N_2 > 7.5$ t and N_3 .

If vehicles of these categories cannot fulfil the requirements by using a front mirror or a camera/monitor device, a vision support system shall be used. In the case of a vision support system this device shall be able to detect an object of 50 cm height and with a diameter of 30 cm within the field defined in Figure 9.

Figure 9
Field of vision of Class VI front mirror

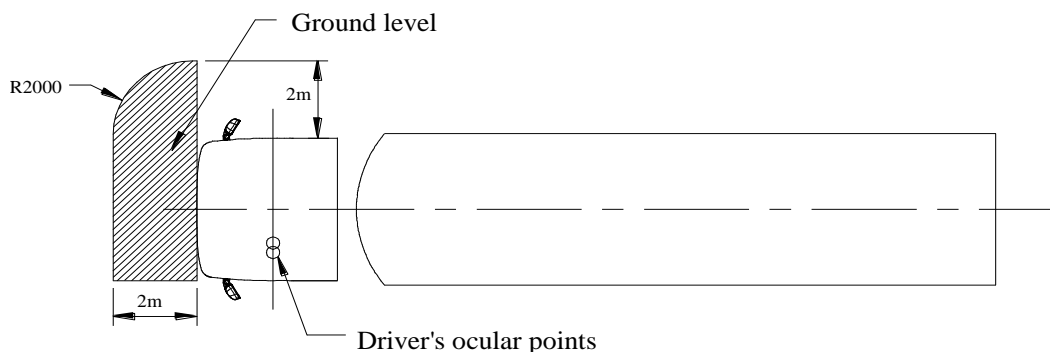

- 15.2.4.6.2. However, if the driver can see, taking into account the obstructions by the A-pillars, a straight line 300 mm in front of the vehicle at a height of 1,200 mm above the road surface and which is situated between a longitudinal vertical plane parallel to the longitudinal vertical median plane going through the outermost side of the vehicle at the driver's side and a longitudinal vertical plane parallel to the longitudinal vertical median plane 900 mm outside the outermost side of the vehicle opposite to the driver's side, a front mirror of Class VI is not mandatory.
- 15.2.4.6.3. For the purpose of paragraphs 15.2.4.6.1. and 15.2.4.6.2. above parts permanently attached to the vehicle that are situated both above the driver's eye points and in front of the transverse vertical plane passing through the foremost surface of the vehicle's front bumper shall not be taken into account when defining the front of the vehicle.
- 15.2.4.7. L-category mirror (Class VII).
- 15.2.4.7.1. Exterior rear-view mirror on the driver's side
- The field of vision shall be such that the driver can see at least a 2.50 m wide, flat, horizontal portion of the road, which is bounded by a plane parallel to the median longitudinal vertical plane and passing through the outermost point of the vehicle on the driver's side of the vehicle and extends from 10 m behind the driver's ocular points to the horizon (see Figure 10).
- 15.2.4.7.2. Exterior rear-view mirror on the passenger's side
- The field of vision shall be such that the driver can see at least a 4 m wide flat, horizontal portion of the road which is bounded by a plane parallel to the median longitudinal vertical plane passing through the outermost point of the vehicle on the passenger's side and which extends from 20 m behind the driver's ocular points to the horizon (see Figure 10).

Figure 10
Field of vision of Class VII mirrors

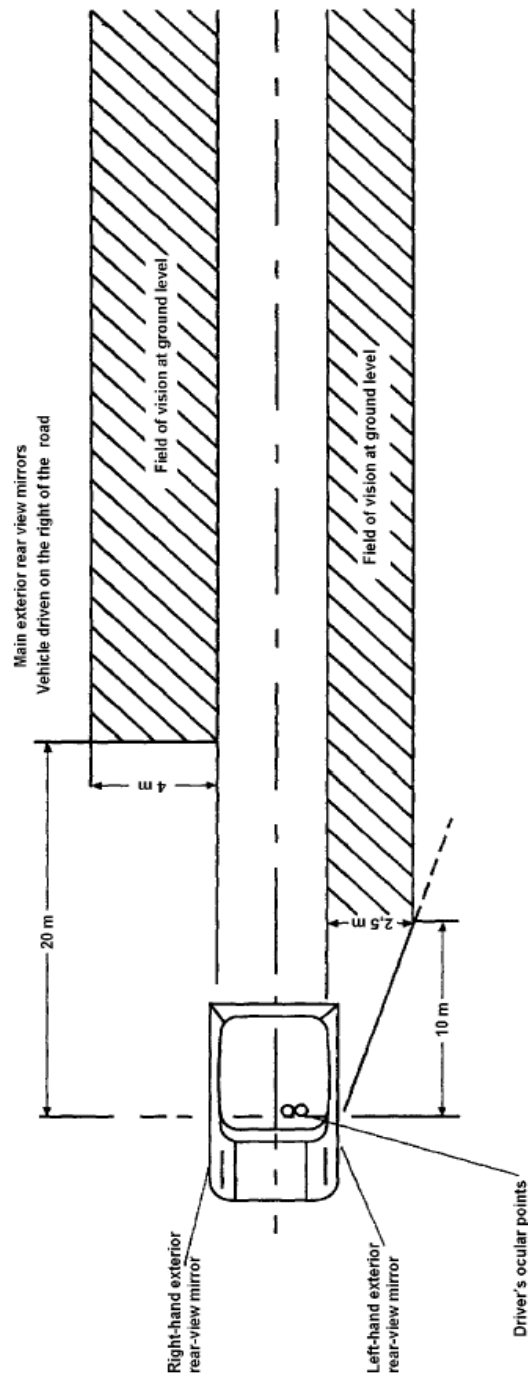

- 15.2.4.8. In the case of mirrors consisting of several reflecting surfaces which are either of different curvature or make an angle with each other, at least one of the reflecting surfaces shall provide the field of vision and have the dimensions (paragraph 6.1.2.1.2.2. of this Regulation) specified for the class to which they belong.
- 15.2.4.9. Obstructions
- 15.2.4.9.1. Interior rear-view mirror (Class I)
- The field of vision may be reduced by the presence of devices such as sun visors, windscreen wipers, heating elements and stop lamp of category S3, provided that all these devices together do not obscure more than 15 per cent of the prescribed field of vision. Headrests or framework or bodywork such as window columns of rear split doors, rear window frame shall be excluded from the calculation. This requirement shall be tested by projection on to a vertical plane at right angles to the longitudinal centreplane of the vehicle. The degree of obstruction shall be measured with the sun visors folded back.
- 15.2.4.9.2. Exterior mirrors (Classes II, III, IV, V, VI and VII)
- In the fields of vision specified above, obstruction due to the bodywork and its components, such as other cab mirrors, door handles, outline marker lights, direction indicators and front and rear bumpers, as well as reflective-surface cleaning components, shall not be taken into account if they are responsible for a total obstruction of less than 10 per cent of the specified field of vision. In the case of a vehicle designed and constructed for special purposes where, due to its special features, it is not possible to meet this requirement, the obstruction of the required field of vision of a Class VI mirror caused by the special features may be more than 10 per cent but not more than necessary for its special function.
- 15.2.4.10. Test procedure
- The field of vision shall be determined by placing powerful light sources at the ocular points and examining the light reflected on the vertical monitoring screen. Other equivalent methods may be used.
- 15.3. Devices for indirect vision other than mirrors
- 15.3.1. A device for indirect vision shall give such performances that a critical object can be observed by the driver over the entire required field of vision, taking into account the critical perception according to the procedure of Annex 10.
- Alternatively, the determination of the displayed object size shall be performed according to Annex 11.
- 15.3.2. Obstruction of the driver's direct view caused by the installation of a device for indirect vision shall be restricted to a minimum.
- 15.3.3. (Reserved)
- 15.3.4. Installation requirements for the monitor
- The viewing direction of the monitor shall roughly be the same direction as the one for the main mirror.
- 15.3.5. Vehicles may be equipped with additional devices for indirect vision.
- 15.3.6. The provisions of this Regulation do not apply to the surveillance camera-monitor-recording devices defined in paragraph 2.1.2.13. of this

Regulation. Exterior surveillance cameras either shall be mounted at least 2 m above the ground when the vehicle is under a load corresponding to its maximum technical permissible mass, or, if their lower edge is less than 2 m from the ground, shall not project more than 50 mm beyond the overall width of the vehicle measured without this device and have a radii of curvature of not less than 2.5 mm.

16. Modifications of the vehicle type and extension of approval

16.1. Every modification of the vehicle type shall be notified to the Type Approval Authority which approved the vehicle type. Type Approval Authority shall then either:

- (a) Decide, in consultation with the manufacturer, that a new type approval is to be granted, or
- (b) Apply the procedure contained in paragraph 16.1.1. (Revision) and, if applicable, the procedure contained in paragraph 16.1.2. (Extension).

16.1.1. Revision

When particulars recorded in the information folder have changed and the Type Approval Authority considers that the modifications made are unlikely to have an appreciable adverse effect, and that in any case the vehicle still complies with the requirements, the modification shall be designated a "revision".

In such a case, the Type Approval Authority shall issue the revised pages of the information folder as necessary, marking each revised page to show clearly the nature of the modification and the date of re-issue. A consolidated, updated version of the information folder, accompanied by a detailed description of the modification, shall be deemed to meet this requirement.

16.1.2. Extension

The modification shall be designated an "extension" if, in addition to the change of the particulars recorded in the information folder,

- (a) Further inspections or tests are required, or
- (b) Any information on the communication document (with the exception of its attachments) has changed, or
- (c) Approval to a later series of amendments is requested after its entry into force.

16.2. Confirmation or refusal of approval, specifying the alterations, shall be communicated to the Parties to the Agreement which apply this Regulation by means of a form conforming to the model in Annex 4 to this Regulation. In addition, the index to the information package, attached to the communication document, shall be amended accordingly to show the date of the most recent revision or extension.

16.3. The Type Approval Authority issuing the extension of approval shall assign a series number to each communication form drawn up for such an extension.

17. Conformity of production

- 17.1. The conformity of production procedure shall comply with those set out in the Agreement, Appendix 2, (E/ECE/324-E/ECE/TRANS/505/Rev.2).
- 17.2. Every vehicle approved under this Regulation shall be so manufactured as to conform to the type approved by meeting the requirements set out in paragraph 15. above.

18. Penalties for non-conformity of production

- 18.1. The approval granted in respect of a vehicle type pursuant to this Regulation may be withdrawn if the requirement laid down in paragraph 17.1. above is not complied with or if the vehicle fails to pass the checks prescribed in paragraph 17.2. above.
- 18.2. If a Party to the Agreement which applies this Regulation withdraws an approval it has previously granted, it shall forthwith so notify the other Contracting Parties applying this Regulation by means of a copy of the approval form bearing at the end, in large letters, the signed and dated annotation "APPROVAL WITHDRAWN".

19. Production definitively discontinued

If the holder of the approval completely ceases to manufacture a type of vehicle approved in accordance with this Regulation, he shall so inform the authority which granted the approval. Upon receiving the relevant communication, that authority shall inform thereof the other Parties to the Agreement applying this Regulation by means of a copy of the approval form bearing at the end, in large letters, the signed and dated annotation "PRODUCTION DISCONTINUED".

20. Names and addresses of Technical Services responsible for conducting approval tests, and of Type Approval Authorities

The Parties to the Agreement applying this Regulation shall communicate to the United Nations Secretariat the names and addresses of the Technical Services responsible for conducting approval tests and of the Type Approval Authorities which grant approval and to which forms certifying approval or refusal or extension or withdrawal of approval, issued in other countries, are to be sent.

21. Transitional provisions

- 21.1. As from the official date of entry into force of the 03 series of amendments to this Regulation, no Contracting Party applying this Regulation shall refuse an application for approval under this Regulation as amended by the 03 series of amendments.
- 21.2. As from 12 months after entry into force of the 03 series of amendments to this Regulation, Contracting Parties applying this Regulation shall

- grant approvals to a type of device for indirect vision only if the type meets the requirements of this Regulation as amended by the 03 series of amendments.
- 21.3. As from 18 months after entry into force of the 03 series of amendments to this Regulation, Contracting Parties applying this Regulation shall grant approvals to a type of vehicle with regard to the installation of devices for indirect vision only if the type of vehicle meets the requirements of this Regulation as amended by the 03 series of amendments.
- 21.4. As from 24 months after entry into force of the 03 series of amendments to this Regulation, Contracting Parties applying this Regulation may refuse to recognize approvals of a type of vehicle with regard to the installation of a camera-monitor device for indirect vision or type of camera-monitor device for indirect vision which have not been granted in accordance with the 03 series of amendments to this Regulation.
- 21.5. As from 26 January 2010 for vehicles of category M₁ and N₁ and from 26 January 2007 for vehicles of other categories, Contracting Parties applying this Regulation may refuse to recognize approvals of a device for indirect vision which have not been granted in accordance with the 02 series of amendments to this Regulation.
- 21.6. Approvals which were granted to devices for indirect vision of Classes I or III pursuant to this Regulation in its original form (00 series) or modified by the 01 or 02 series of amendments before the date of entry into force of this series of amendments shall remain valid.
- 21.7. Notwithstanding the provisions of paragraph 21.2, approvals which were granted to mirrors of Classes II, IV, V, VI or VII pursuant to this Regulation as modified by the 02 series of amendments before the date of entry into force of this series of amendments shall remain valid.
- 21.8. The provisions of this Regulation shall not prohibit the approval of a type of vehicle with regard to the mounting of devices for indirect vision pursuant to this Regulation as modified by the 03 series of amendments, if all or part of the devices for indirect vision of Classes I or III, with which it is fitted, bear the approval mark prescribed by this Regulation in its original form (00 series) or modified by the 01 or 02 series of amendments.
- 21.9. The provisions of this Regulation shall not prohibit the approval of a type of vehicle with regard to the mounting of devices for indirect vision pursuant to this Regulation as modified by the 03 series of amendments, if all or part of the rear-view mirrors of Classes II, IV, V, VI or VII, with which it is fitted, bear the approval mark prescribed by the 02 series of amendments of this Regulation.
- 21.10. Notwithstanding the provisions of paragraphs 21.2., 21.4. and 21.5. above, for the purpose of replacement parts, Contracting Parties applying this Regulation shall continue to grant approvals according to the 01 series of amendments to this Regulation, to devices for indirect vision of Classes I to V and VII for use on vehicle types which have been approved before 26 January 2006 pursuant to the 01 series of amendments of Regulation No. 46 and to devices for indirect vision of class VI for use on vehicles which have been approved before 26 January 2007 pursuant to the 01 series of amendments of Regulation No. 46, and, where applicable, subsequent extensions to these approvals.

- 21.11. Notwithstanding the provisions of paragraphs 21.2., 21.4. and 21.5. above, for the purpose of replacement parts Contracting Parties applying this Regulation shall continue to grant approvals according 02 series of amendments to this Regulation, to devices for indirect vision for use on vehicle types which have been approved before the date mentioned in paragraph 21.2. above pursuant to the 02 series of amendments of Regulation No. 46, and, where applicable, subsequent extensions to these approvals.
- 21.12. As from the official date of entry into force of the 04 series of amendments to this Regulation, no Contracting Party applying this Regulation shall refuse an application for approval under this Regulation as amended by the 04 series of amendments.
- 21.13. As from 30 June 2014, Contracting Parties applying this Regulation shall grant approvals to a type of device for indirect vision only if the type of device meets the requirements of this Regulation as amended by the 04 series of amendments.
- 21.14. As from 30 June 2014, Contracting Parties applying this Regulation shall grant approvals to a type of vehicle with regard to the installation of devices for indirect vision only if the type of vehicle meets the requirements of this Regulation as amended by the 04 series of amendments.
- 21.15. As from 30 June 2015, Contracting Parties applying this Regulation shall not be obliged to accept approvals of a type of vehicle or type of device for indirect vision which have not been granted in accordance with the 04 series of amendments to this Regulation.
- 21.16. Notwithstanding paragraph 21.15. above, type approvals granted to the preceding series of amendments to the Regulation, which are not affected by the 04 series of amendments, shall remain valid and Contracting Parties applying this Regulation shall continue to accept them.
- 21.17. Contracting Parties applying this Regulation shall not refuse to grant extensions of type approvals for existing types of vehicles or devices, which are not affected by the 04 series of amendments, granted according to the 03 series of amendments to this Regulation.

Annex 1

Information document for type approval of a device for indirect vision

The following information, if applicable, shall be supplied in triplicate and shall include a list of contents.

Any drawings shall be supplied in appropriate scale and in sufficient detail on size A4 paper or on a folder of A4 format.

Photographs, if any, shall show sufficient details.

1. Make (trade name of manufacturer):
2. Type and general commercial description(s):
3. Means of identification of the type, if indicated on the device:
4. Category of vehicle for which the device is intended:
5. Name and address of manufacturer:
6. Location and method of affixing of the approval mark:
7. Address(es) of assembly plant(s):
8. Mirrors (state for each mirror):
- 8.1. Variant
- 8.2. Drawing(s) for the identification of the mirror:
- 8.3. Details of the method of attachment:
9. Devices for indirect vision other than mirrors:
- 9.1. Type and characteristics (such as a complete description of the device):
- 9.1.1. In the case of camera-monitor device, the detection distance (mm), contrast, luminance range, glare correction, display performance (black and white/colour) image repetition frequency, luminance reach of the monitor:
- 9.2. Sufficiently detailed drawings to identify the complete device including installation instructions; the position for the type-approval mark has to be indicated on the drawings:

Annex 2

Information document for type-approval of a vehicle with respect to the installation of devices for indirect vision

The following information, if applicable, shall be supplied in triplicate and include a list of contents.

Any drawings shall be supplied in appropriate scale and in sufficient detail on size A4 paper or on a folder of A4 format.

Photographs, if any, shall show sufficient details.

General

1. Make (trade name of manufacturer):
2. Type and general commercial description(s):
3. Means of identification of type, if marked on the vehicle:
4. Location of that marking:
5. Category of vehicle:
6. Name and address of manufacturer:
7. Address(es) of assembly plant(s):

General construction characteristics of the vehicle

8. Photograph(s) and/or drawing(s) of a representative vehicle:
9. Driving cab (forward control or bonneted)¹:
10. Driving position: left/right¹
- 10.1. The vehicle is equipped to be driven in right-hand/left hand traffic¹
11. Range of vehicle dimensions (overall):
- 11.1 For chassis without bodywork
- 11.1.1. Width²:

¹ Delete where not applicable

² "Overall width" of a vehicle means a dimension which is measured according to ISO standard 612-1978, term No. 6.2. In case of vehicles of category other than M₁, in addition to the provisions of that standard, when measuring the vehicle width the following devices shall not be taken into account:

- (a) customs sealing devices and their protection,
- (b) devices for securing the tarpaulin and their protection,
- (c) tyre failure tell-tale devices,
- (d) protruding flexible parts of a spray-suppression system,
- (e) lighting equipment,
- (f) for buses, access ramps in running order, lifting platforms and similar equipment in running order provided that they do not exceed 10 mm from the side of the vehicle and the corners of the ramps facing forwards or rearwards are rounded to a radius of not less than 5 mm; the edges shall be rounded to a radius of not less than 2.5 mm,
- (g) devices for indirect vision,
- (h) tyre-pressure indicators,
- (i) retractable steps,
- (j) the deflected part of the tyre walls immediately above the point of contact with the ground.

- 11.1.1.1. Maximum permissible width:
- 11.1.1.2. Minimum permissible width:
- 11.2. For chassis with bodywork:
- 11.2.1. Width²
- 12. Bodywork
 - 12.1. Devices for indirect vision
 - 12.1.1. Mirrors.....
 - 12.1.1.1. Drawing(s) showing the position of the mirror relative to the vehicle structure:
 - 12.1.1.2. Details of the method of attachment including that part of the vehicle structure to which it is attached:.....
 - 12.1.1.3. Optional equipment which may affect the rearward field of vision:
 - 12.1.1.4. A brief description of the electronic components (if any) of the adjustment device:
 - 12.1.2. Devices for indirect vision other than mirrors:
 - 12.1.2.1. Sufficiently detailed drawings with the installation instructions:

Annex 3

Communication

(Maximum format: A4 (210 x 297 mm))



issued by :

Name of administration:

.....

concerning²:

- Approval granted
- Approval extended
- Approval refused
- Approval withdrawn
- Production definitively discontinued

of a type of device for indirect vision pursuant to Regulation No. 46

Approval No. Extension No.

1. Trade name or mark of device:
2. Manufacturer's name for the type of device:
3. Manufacturer's name and address:
4. If applicable, name and address of manufacturer's representative:
5. Submitted for approval on:
6. Technical Service responsible for conducting approval tests:
7. Date of report issued by that Service
8. Number of report issued by that Service.....
9. Brief description
- Identification of the device: mirror, camera/monitor, other device²
- Device for indirect vision of Classes I, II, III, IV, V, VI, S²
- Symbol $\frac{\Delta}{2m}$ as defined in paragraph 6.1.3.1.1. of this Regulation: yes/no²
10. Position of the approval mark:.....
11. Reason(s) for extension (if applicable):.....
12. Approval granted/refused/extended/withdrawn²:
13. Place:
14. Date:

¹ Distinguishing number of the country which has granted/extended/refused/withdrawn approval (see approval provisions in the Regulations).

² Strike out what does not apply.

15. Signature:
16. The list of documents deposited with the Type Approval Authority which has granted approval is annexed to this communication and may be obtained on request.

Annex 4

Communication

(Maximum format: A4 (210 x 297 mm))



issued by :

Name of administration:

.....
.....
.....

concerning²: Approval granted
 Approval extended
 Approval refused
 Approval withdrawn
 Production definitively discontinued

of a type of vehicle with regard to the mounting of devices for indirect vision pursuant to Regulation No. 46

Approval number: Extension No.:

1. Make (trade name of manufacturer):
2. Type and general commercial description(s)
3. Means of identification of type, if marked on the vehicle:
- 3.1. Location of that marking:
4. Category of vehicle: (M₁, M₂, M₃, N₁, N₂ ≤ 7.5t, N₂ > 7.5t, N₃)²
5. Name and address of manufacturer:
6. Address(es) of the production plant(s).....
7. Additional information: (where applicable). See appendix
8. Technical Service responsible for carrying out the tests:.....
9. Date of test report:
10. Number of test report:.....
11. Remarks: (if any). See appendix
12. Place:
13. Date:
14. Signature:.....
15. The index to the information package lodged with the Type Approval Authority, which may be obtained on request is attached.

¹ Distinguishing number of the country which has granted/extended/refused/withdrawn approval (see approval provisions in the Regulations).

² Strike out what does not apply.

Annex 4 – Appendix

Appendix to type approval communication form No.
concerning the type approval of a vehicle with regard to the mounting of devices
for indirect vision under Regulation No.46

1. Trade name or mark of mirrors and supplementary devices for indirect vision and component type-approval number:
2. Class(es) of mirrors and devices for indirect vision (I, II, III, IV, V, VI, VII, S)¹
3. Extension of type approval of the vehicle to cover the following device for indirect vision
4. Data for identification of the R point of the driver's seating position:
5. Maximum and minimum bodywork width in respect of which the mirror and the devices for indirect vision has been granted type-approval (in the case of chassis/cab referred to in paragraph 15.2.2.3. of this Regulation)
6. The following documents, bearing the type approval number shown above, are annexed to this certificate:
- (a) Drawings showing the mounting of the devices for indirect vision.....
- (b) Drawings and plans showing the mounting position and characteristics of the part of the structure where the devices for indirect vision are mounted.....
7. Remarks: (e.g. valid for right hand/left hand traffic¹).....

¹ Strike out what does not apply.

Annex 5

Arrangement of approval mark of a device for indirect vision

(See paragraph 5.4. of the Regulation)

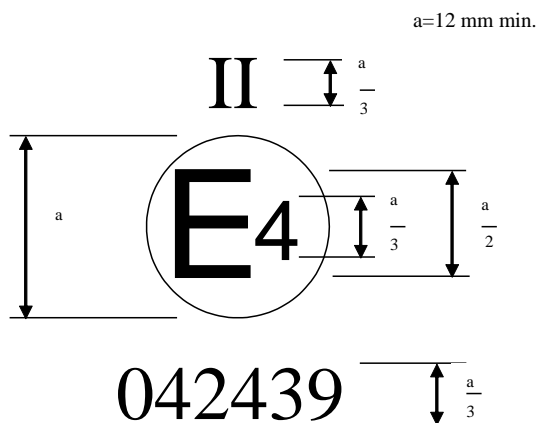

The above approval mark affixed to a device for indirect vision indicates that the mirror is a rear view mirror, of Class II, which has been approved in the Netherlands (E 4) pursuant to Regulation No. 46 and under approval number 042439. The first two digits of the approval number indicate that Regulation No. 46 already included the 04 series of amendments when the approval was granted.

Note: The approval number and the additional symbol shall be placed close to the circle and either above or below the "E" or to the left or right of that letter. The digits of the approval number shall be on the same side of the "E" and point in the same direction. The additional symbol shall be directly opposite the approval number. The use of Roman numerals as approval numbers shall be avoided so as to prevent any confusion with other symbols.

Annex 6

Test method for determining reflectivity

1. Definitions
 - 1.1. CIE standard illuminate A¹: Colorimetric illuminate, respecting the full radiator at $T_{68} = 2,855.6$ K.
 - 1.1.2. CIE standard source A¹: Gas-filled tungsten filament lamp operating at a correlated colour temperature of $T_{68} = 2,855.6$ K.
 - 1.1.3. CIE 1931 standard colorimetric observer¹: Receptor of radiation whose colorimetric characteristics correspond to the spectral tristimulus values $\bar{x}(\lambda)$, $\bar{y}(\lambda)$, $\bar{z}(\lambda)$ (see table).
 - 1.1.4. CIE spectral tristimulus values¹: Tristimulus values of the spectral components of an equi energy spectrum in the CIE (XYZ) system.
 - 1.1.5. Photopic vision¹: Vision by the normal eye when it is adapted to levels of luminance of at least several cd/m^2 .
2. Apparatus
 - 2.1. General

The apparatus shall consist of a light source, a holder for the test sample, a receiver unit with a photodetector and an indicating meter (see Figure 1), and means of eliminating the effects of extraneous light.

The receiver may incorporate a light-integrating sphere to facilitate measuring the reflectance of non-flat (convex) mirrors (see Figure 2).
 - 2.2. Spectral characteristics of light source and receiver

The light source shall consist of a CIE standard source A and associated optics to provide a near-collimated light beam. A voltage stabiliser is recommended in order to maintain a fixed lamp voltage during instrument operation.

The receiver shall have a photodetector with a spectral response proportional to the photopic luminosity function of the CIE (1931) standard colorimetric observer (see table). Any other combination of illuminate-filter-receptor giving the overall equivalent of CIE standard illuminate A and photopic vision may be used. When an integrating sphere is used in the receiver, the interior surface of the sphere shall be coated with a matt (diffusive) spectrally non-selective white coating.
 - 2.3. Geometrical conditions

The angle of the incident beam (θ) should preferably be 0.44 ± 0.09 rad ($25 \pm 5^\circ$) from the perpendicular to the test surface and shall not exceed the upper limit of the tolerance (i.e. 0.53 rad or 30°). The axis of the receptor shall make an angle (θ) with this perpendicular equal to that of the incident beam (see Figure 1). The incident beam upon arrival at the

¹ Definitions taken from CIE publication 50 (45), International Electrotechnical Vocabulary, Group 45, Lighting

test surface shall have a diameter of not less than 13 mm (0.5 inch). The reflected beam shall not be wider than the sensitive area of the photodetector, shall not cover less than 50 per cent of such area, and as nearly as possible shall cover the same area segment as used during instrument calibration.

When an integrating sphere is used in the receiver section, the sphere shall have a minimum diameter of 127 mm (5 inch). The sample and incident beam apertures in the sphere wall shall be of such a size as to admit the entire incident and reflected light beams. The photodetector shall be so located as not to receive direct light from either the incident or the reflected beam.

2.4. Electrical characteristics of the photodetector-indicator unit

The photodetector output as read on the indicating meter shall be a linear function of the light intensity of the photosensitive area. Means (electrical and/or optical) shall be provided to facilitate zeroing and calibration adjustments. Such means shall not affect the linearity or the spectral characteristics of the instrument. The accuracy of the receptor indicator unit shall be within ± 2 per cent of full scale, or ± 10 per cent of the magnitude of the reading, whichever is the smaller.

2.5. Sample holder

The mechanism shall be capable of locating the test sample so that the axes of the source arm and receptor intersect at the reflecting surface. The reflecting surface may lie within or at either face of the mirror sample, depending on whether it is a first surface, second surface or prismatic "flip" type mirror.

3. Procedure

3.1. Direct calibration method

In the direct calibration method, air is used as the reference standard. This method is applicable for those instruments, which are so constructed as to permit calibration at the 100 per cent point by swinging the receiver to a position directly on the axis of the light source (see Figure 1).

It may be desired in some cases (such as when measuring low-reflectivity surfaces) to use an intermediate calibration point (between 0 and 100 per cent on the scale) with this method. In these cases, a neutral density filter of known transmittance shall be inserted in the optical path, and the calibration control shall then be adjusted until the meter reads the percentage transmission of the neutral density filter. This filter shall be removed before reflectivity measurements are performed.

3.2. Indirect calibration method

The indirect calibration method is applicable in the case of instruments with fixed source and receiver geometry. A properly calibrated and maintained reflectance standard is required. This reference standard should preferably be a flat mirror with a reflectance value as near as possible to that of the test samples.

3.3. Flat mirror measurement

The reflectance of flat mirror samples can be measured on instruments employing either the direct or the indirect calibration method. The reflectance value is read directly from the indicating meter.

3.4. Non-flat (convex) mirror measurement

Measurement of the reflectance of non-flat (convex) mirrors requires the use of instruments which incorporate an integrating sphere in the receiver unit (see Figure 2). If the instrument-indicating meter indicates n_e divisions with a standard mirror of E per cent reflectance, then, with a mirror of unknown reflectance, n_x divisions will correspond to a reflectance of X per cent, in accordance with the formula:

$$X = E \frac{n_x}{n_e}$$

Figure 1

Generalised reflectometer showing experimental set-ups for the two calibration methods

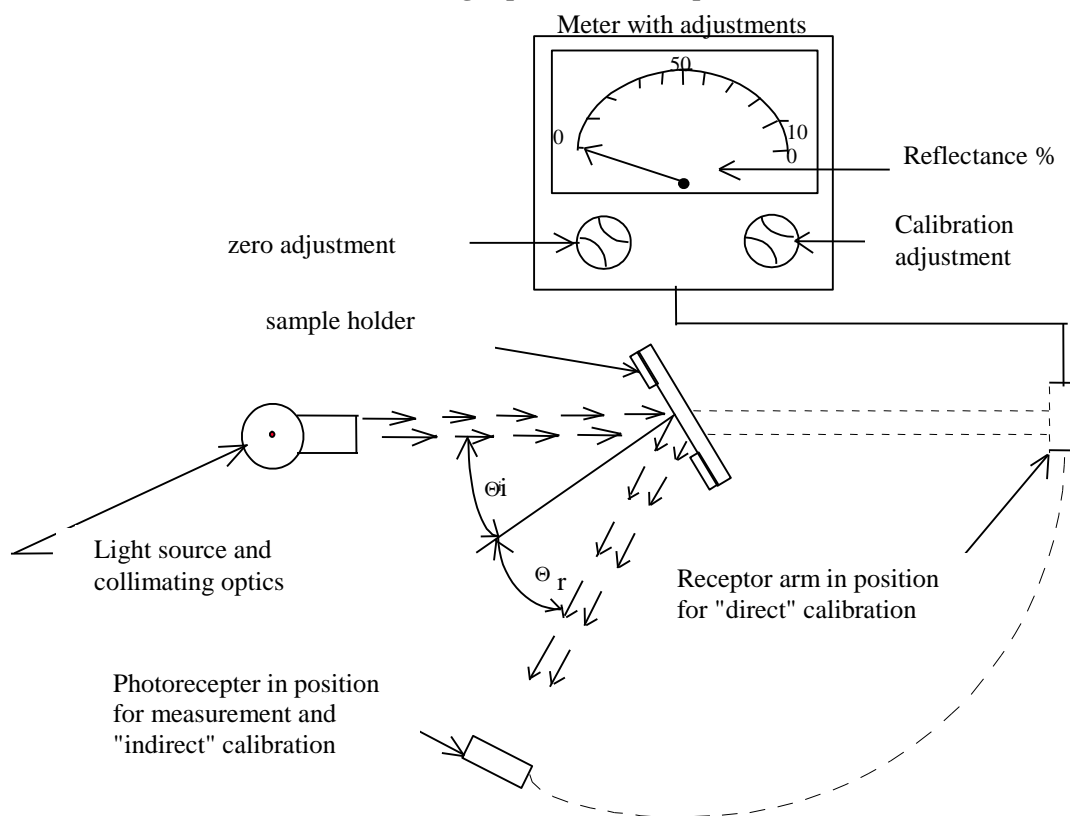
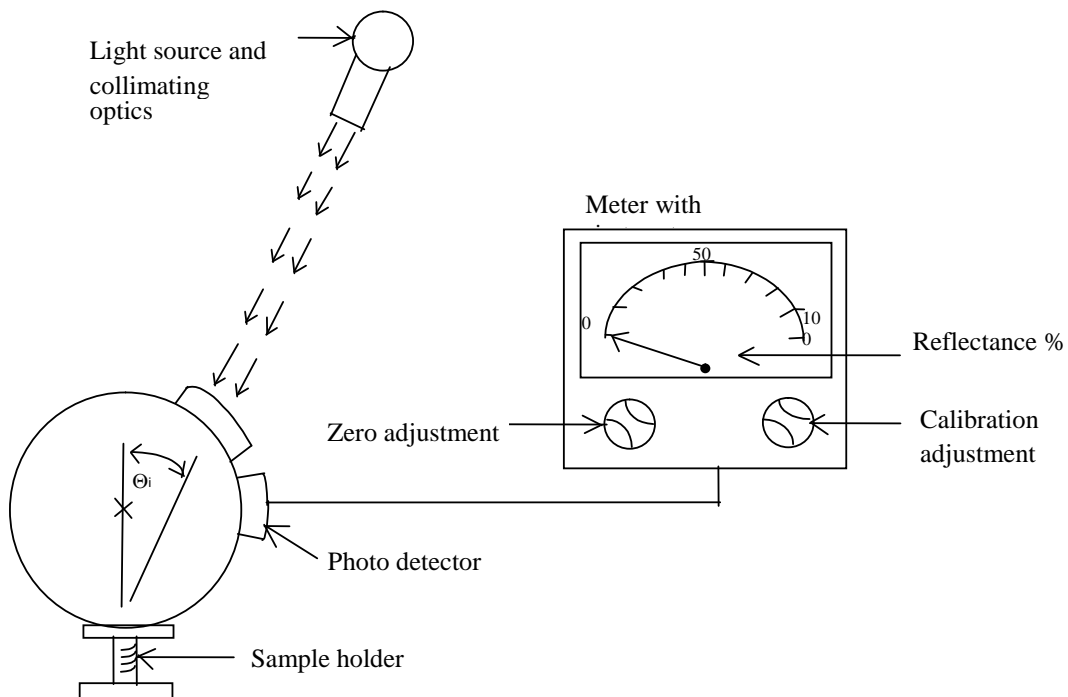

Figure 2
Generalised reflectometer, incorporating an integrating sphere in the receiver



4. Spectral tristimulus values for the CIE 1931 standard
colormetric observer²

This table is taken from CIE publication 50 (45) (1970)

λ nm	$\bar{x}(\lambda)$	$\bar{y}(\lambda)$	$\bar{z}(\lambda)$
380	0.001 4	0.000 0	0.006 5
390	0.004 2	0.000 1	0.020 1
400	0.014 3	0.000 4	0.067 9
410	0.043 5	0.001 2	0.207 4
420	0.134 4	0.004 0	0.645 6
430	0.283 9	0.011 6	1.385 6
440	0.348 3	0.023 0	1.747 1
450	0.336 2	0.038 0	1.772 1
460	0.290 8	0.060 0	1.669 2
470	0.195 4	0.091 0	1.287 6
480	0.095 6	0.139 0	0.813 0
490	0.032 0	0.208 0	0.465 2
500	0.004 9	0.323 0	0.272 0
510	0.009 3	0.503 0	0.158 2
520	0.063 3	0.710 0	0.078 2
530	0.165 5	0.862 0	0.042 2
540	0.290 4	0.954 0	0.020 3
550	0.433 4	0.995 0	0.008 7
560	0.594 5	0.995 0	0.003 9
570	0.762 1	0.952 0	0.002 1
580	0.916 3	0.870 0	0.001 7
590	1.026 3	0.757 0	0.001 1
600	1.062 2	0.631 0	0.000 8
610	1.002 6	0.503 0	0.000 3
620	0.854 4	0.381 0	0.000 2
630	0.642 4	0.265 0	0.000 0
640	0.447 9	0.175 0	0.000 0
650	0.283 5	0.107 0	0.000 0
660	0.164 9	0.061 0	0.000 0
670	0.087 4	0.032 0	0.000 0
680	0.046 8	0.017 0	0.000 0
690	0.022 7	0.008 2	0.000 0
700	0.011 4	0.004 1	0.000 0
710	0.005 8	0.002 1	0.000 0
720	0.002 9	0.001 0	0.000 0
730	0.001 4	0.000 5	0.000 0
740	0.000 7	0.000 2 (*)	0.000 0
750	0.000 3	0.000 1	0.000 0
760	0.000 2	0.000 1	0.000 0
770	0.000 1	0.000 0	0.000 0
780	0.000 0	0.000 0	0.000 0

(*) Changed in 1966 (from 3 to 2)

² Abridged table. The values of $\bar{y}(\lambda) = V(\lambda)$ are rounded off to four decimal places

Explanatory figure

Example of device for measuring the reflection factor of spherical mirrors

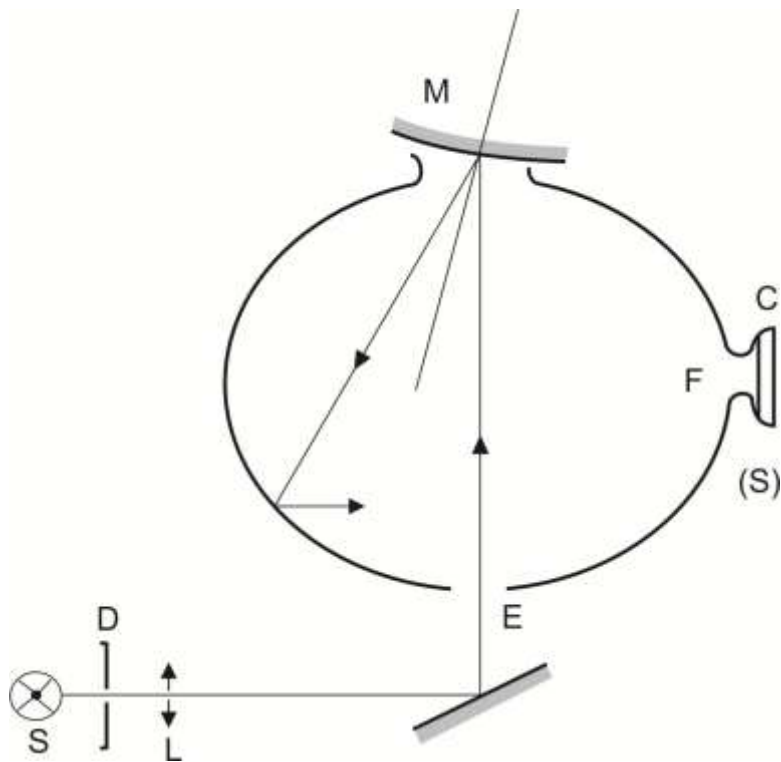

- C = Receiver
- D = Diaphragm
- E = Window of entry
- F = Window of measurement
- L = Lens
- M = Object window
- S = Light source
- (S) = Integrating sphere

Annex 7

Procedure for determining the radius of curvature "r" of the reflecting surface of a mirror

1. Measurement
 - 1.1. Equipment

A "spherometer" similar to the one described in Figure 1 of this annex having the indicated distances between the tracing pin of the dial gauge and the fixed legs of the bar is used.
 - 1.2. Measuring points
 - 1.2.1. The principal radii of curvature shall be measured at three points situated as close as possible to positions at one-third, one-half and two-thirds of the distance along the arc of the reflecting surface passing through the centre of this surface and parallel to segment b, or of the arc passing through the centre of the reflecting surface which is perpendicular to it if this arc is the longer.
 - 1.2.2. Where, owing to the size of the reflecting surface, it is impossible to obtain measurements in the directions defined in paragraph 2.1.1.6. of this Regulation, the Technical Services responsible for the tests may take measurements at the said point in two perpendicular directions as close as possible to those prescribed above.
2. Calculation of the radius of curvature "r"

"r" expressed in mm is calculated from the formula:

$$r = \frac{r_p1 + r_p2 + r_p3}{3}$$

Where:

- r_p1 = the radius of curvature at the first measuring point,
 r_p2 = the radius of curvature at the second measuring point,
 r_p3 = the radius of curvature at the third measuring point.

Figure 1

Spherometer

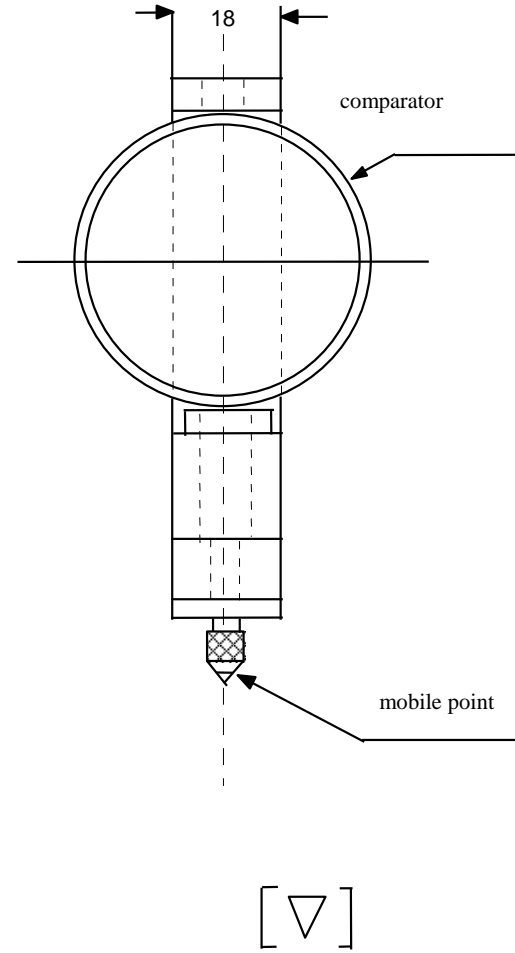
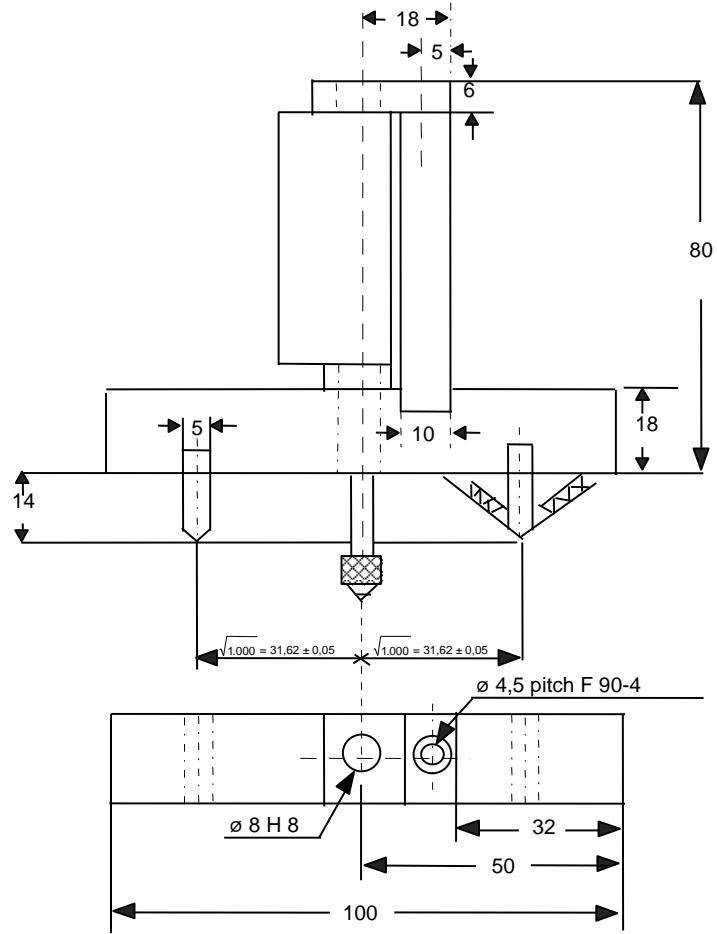

Annex 8

Procedure for determining the "H" point and the actual torso angle for seating positions in motor vehicles¹

Appendix 1 - Description of the three dimensional "H" point machine (3-D H machine)¹

Appendix 2 - Three-dimensional reference system¹

Appendix 3 - Reference data concerning seating positions¹

¹ The procedure is described in Annex 1 to the Consolidated Resolution on the Construction of Vehicles (RE.3) (document ECE/TRANS/WP.29/78/Rev.2).
www.unece.org/trans/main/wp29/wp29wgs/wp29gen/wp29resolutions.html

Annex 9

(Reserved)

Annex 10

Calculation of the detection distance

1. Camera monitor device for indirect vision

1.1. Determination of the smallest discernable detail

The smallest discernable detail of the naked eye shall be defined according to standard ophthalmologic tests like the Landolt C test or the Triangle Orientation Discrimination (TOD) test. The smallest discernable detail at the centre of the viewing system can be determined using the Landolt C test or the TOD test. In the rest of the viewing area the smallest discernable detail may be estimated from the centrally determined smallest discernable detail and the local image deformation. For instance, in the case of a digital camera the smallest discernable detail at a given pixel location (in the monitor) scales inversely with the solid angle of the pixel.

1.1.1. Landolt-C test

In the Landolt-C test, test symbols are judged by the subject under test. In accordance with this test the smallest discernable detail is defined as the visual angle of the gap size of the Landolt C symbol at threshold size and is expressed in arcmin. The threshold size corresponds to the size at which the subject judges the orientation correctly in 75 per cent of the trials. The smallest discernable detail is determined in a test involving a human observer. A test chart containing test symbols is placed in front of the camera and the observer judges the orientation of test symbols from the monitor. From the threshold gap size of the Landolt C test symbol d (m) and the distance between the test pattern and the camera D (m) the smallest discernable detail ω_c (arcmin) is calculated as follows:

$$\omega_c = \frac{d}{D} \cdot \frac{180 \cdot 60}{\pi}$$

1.1.2. TOD test

The Landolt C test can be used to determine the smallest discernable detail of the camera-monitor system. However, for sensor systems it is more suitable to use the TOD (Triangle Orientation Discrimination) method which is similar to the Landolt C method, but involves equilateral triangular test patterns. The Triangle Orientation Discrimination method is described in detail by Bijl & Valeton (1999), who provide practical guidelines on how to perform a TOD measurement. In the method, triangular test patterns (see Figure 1) are viewed through the viewing system under test. Each triangle can have one out of four possible orientations (apex up, left, right or down) and the observer indicates/guesses for each triangle its orientation. When this procedure is repeated for many (randomly oriented) triangles of different sizes the fraction of correct responses can be plotted (see Figure 2), and increases with test pattern size. The threshold is defined as the point at which the fraction correct crosses the 0.75 level and can be obtained by fitting a smooth function through the data (see Bijl & Valeton, 1999). Critical perception is reached when the critical object diameter equals two times the width of the triangle at threshold size. The smallest discernable detail (ω_c) is

equal to 0.25 times the width of the triangle at threshold size. This means that, from the threshold triangle width w (in m) and the distance between test pattern and the camera D (in m) the smallest discernable detail ω_c (in arcmin) is calculated as follows:

$$\omega_c = \frac{w}{4 \cdot D} \cdot \frac{180 \cdot 60}{\pi}$$

Figure 1
Triangular test patterns used in the Triangle Orientation Discrimination (TOD) method

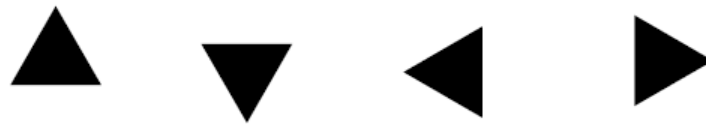
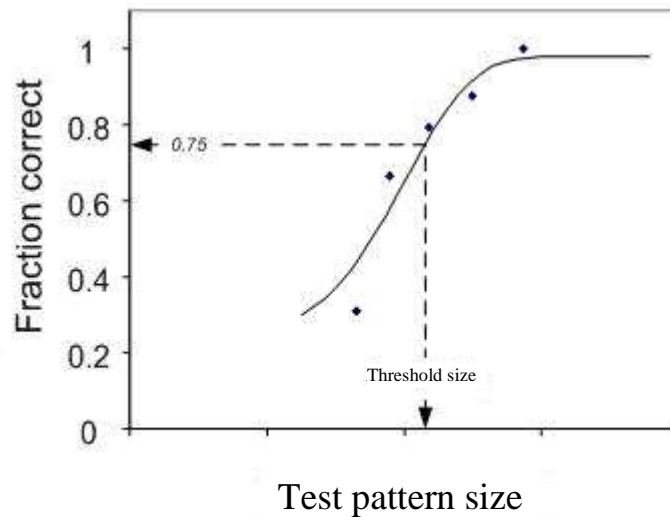

Figure 2
Typical relationship between the size of the triangle and the fraction of correct responses.



1.2. Determination of the critical viewing distance of the monitor

For a monitor having certain dimensions and properties, the distance to the monitor can be calculated within which the detection distance is dependent only on the performances of the camera. The critical viewing distance r_{crit} is defined as the distance at which the smallest discernable detail displayed on the monitor spans 1 arcmin measured from the eye (the acuity threshold of a standard observer).

$$r_{\text{crit}} = \frac{\delta \cdot 60 \cdot 180}{\pi}$$

Where:

r_{crit} : critical viewing distance of the monitor (m)

δ : size of the smallest discernable detail on the monitor (m)

- 1.3. Determination of the detection distance
- 1.3.1. Maximum detection distance within the critical viewing distance where, due to the installation, the distance eye-monitor is less than the critical viewing distance, the maximum attainable detection distance is defined as:

$$r_{\text{dclose}} = \frac{D_0 \cdot 60 \cdot 180}{\omega_c \cdot \pi \cdot f}$$

Where:

r_{dclose} : detection distance (m)

D_0 : diameter of the critical object (m) according to paragraph 2.1.2.6. of this Regulation; for the calculation of r_{dclose} for class V and VI devices, a representative value of 0.30 m shall be used

f : threshold increasing factor, which is equal to 8

ω_c : smallest discernable detail (arcmin)

- 1.3.2. Detection distance greater than the critical viewing distance. Where, due to the installation, the distance eye-monitor is more than the critical viewing distance, the maximum obtainable detection distance is defined as:

$$r_{\text{dfar}} = \frac{r_{\text{mcrit}}}{r_m} r_{\text{dclose}} \quad (\text{m})$$

Where:

r_{dfar} : detection distance for distances larger than the critical viewing distance (m)

r_{dclose} : detection distance for distances smaller than the critical viewing distance (m)

r_m : viewing distance, i.e. distance between eye and monitor (m)

r_{mcrit} : critical viewing distance (m)

2. Secondary functional requirements

Based on the installation conditions, a determination shall be made to discover whether the entire device can still satisfy the functional requirements listed in paragraph 6.2.2. of this Regulation, especially the glare correction, the maximum and the minimum luminance of the monitor. It shall also be determined the degree to which the glare correction will be addressed and the angle at which sunlight can strike a monitor and these shall be compared to the corresponding measuring results from the system measurements. This can be either based on a CAD-generated model, a determination of the angles of light for the device when mounted on the relevant vehicle, or by carrying out relevant measurements on the relevant vehicle as described in paragraph 6.2.2.2. of this Regulation.

Annex 11

Determination of the displayed object size

1. Camera monitor device for indirect vision
 - 1.1. General

Determination of the displayed object size considers the possible appearance of smear. The impact on the monitors image and consequence is the occultation of the field of view and therefore of the object. The following differentiation is made:
 - 1.2. Case A: Smear appears
 - 1.2.1. Step 1: Under the condition described in paragraph 6.2.2.1.2. of this Regulation, measure the width (s) of the vertical bar displayed on the monitor e.g. with a measurement microscope.
 - 1.2.2. Step 2: Place the object at a defined distance from the camera. Measure the width of the object displayed on the monitor (b) in a situation without real sun light condition e.g. with a measurement microscope.
 - 1.2.3. Step 3: Calculate the residual object width (α) according to the following equation:

$$\alpha ['] = 60 \times 2 \times \arctan \frac{b-s}{2 \times r}$$

Where:

- α : residual width of the object displayed on the monitor (with smear) (minutes of arc)
- b: width of the object displayed on the monitor (without smear) (mm)
- s: width of the smear (mm)
- r: viewing distance (mm)

- 1.3. Case B: Smear does not appear
 - 1.3.1. Step 1: Place the object at a defined distance from the camera. Measure the width of the object displayed on the monitor (b) in a situation without real sun light condition e.g. with a measurement microscope.
 - 1.3.2. Step 2: Calculate the object width (α) according to the following equation:

$$\alpha ['] = 60 \times 2 \times \arctan \frac{b}{2 \times r}$$

Where:

- α : width of the object displayed on the monitor (without smear) (minutes of arc)
- b: width of the object displayed on the monitor (without smear) (mm)
- r: viewing distance (mm)

1.4. Data supplied by the instructions for use

In case of Classes V and VI camera monitor devices the instructions for use shall include a table that shows the minimum and maximum mounting height of the camera above ground under consideration of different viewing distances. The camera shall be mounted within the applicable height range. The viewing distances shall be selected from the intended context of use. The following table shows an example.

Viewing distance	0.5 m	1.0 m	1.5 m	2.0 m	2.5 m
Minimum mounting height	Para. 1.4.1.	Para. 1.4.1.	Para. 1.4.1.	Para. 1.4.1.	Para. 1.4.1.
Maximum mounting height	Para. 1.4.2.	Para. 1.4.2.	Para. 1.4.2.	Para. 1.4.2.	Para. 1.2.2.

1.4.1. The value of the minimum mounting height is the same for all viewing distances as it is independent of the viewing distance. It is determined by the dimensions of the field of vision and the field of view of the camera. Use the following working steps for determination of the minimum mounting height.

1.4.1.1. Step 1: Draw the intended field of vision on ground.

1.4.1.2. Step 2: Place the camera above the field of vision in such a way that the camera is viewing the field of vision. The lateral position shall be in accordance with the intended mounting position at the vehicle.

1.4.1.3. Step 3: Change the height of the camera above ground in such a way, that the field of vision displayed on the monitor covers an area at least as large as the field of vision. Furthermore, the field of vision display should encompass the entire monitor screen.

1.4.1.4. Step 4: Measure the height between camera and ground which is the minimum mounting height. Report the result value.

1.4.2. The value of the maximum mounting height is different for different viewing distances as the displayed object size varies with the mounting height. Use the following working steps for determination of the maximum mounting height:

1.4.2.1. Step 1: Determine the minimum width b_{\min} of the critical object displayed on the monitor for each viewing distance.

$$b_{\min} = 2 \times r \times \tan \frac{8'}{2 \times 60}$$

Where:

r: viewing distance in mm

b_{\min} : minimum width of the critical object displayed on the monitor in mm

1.4.2.2. Step 2: Place the critical object inside the drawn intended field of vision in a position at which the distance between the critical object and the camera is

largest. The illumination conditions shall be in such a way that the critical object is clearly visible on the monitor.

1.4.2.3. Step 3: Select the first value of the possible viewing distances.

1.4.2.4. Step 4: Change the height of the camera above ground in such a way, that the residual width B of the object displayed on the monitor is equal to the minimum width allocated to that viewing distance.

$$B=b_{\min}$$

Where:

B: residual width of the object displayed on the monitor (which is "b" in cases without smear and "b – s" in cases with smear) in mm (see paragraph 1.1. General)

1.4.2.5. Step 5: Measure the height between camera and ground which is the maximum mounting height allocated to that viewing distance. Report the result value.

1.4.2.6. Step 6: Repeat the aforementioned steps 4 and 5 for the other viewing distances.
